

产品承认书
SPECIFICATION FOR APPROVAL

客户名称 <i>CUSTOMER NAME.</i>	
产品类型 <i>PRODUCT TYPE</i>	贴片共模电感
客户料号 <i>CUSTOMER PN</i>	930101 (744224)
富安料号 <i>OURS PN</i>	FACM-0905C-251
文件编号 <i>FILE NO.</i>	SP-1701020
日期 <i>DATE.</i>	2017/01/07

批准 <i>APPROVED</i>	确认 <i>CHECKED</i>	作成 <i>DESIGN</i>
唐海波	唐海波	李丹

客户承认/ <i>CUSTOMER ACCEPTED</i>		
承认 <i>APPROVED</i>	确认 <i>CHECKED</i>	承办 <i>DESIGN</i>
批注/ <i>REMARK</i>		

客户名称 CUSTOMER		客户品名 CUSTOMER P/N	930101 (744224)	版别 REV.	B版	
产品类型 PRODUCT TYPE	贴片共模电感	富安品名 OURS P/N	FACM-0905C-251	文件编号 FILE NO.	SP-1701020	
一.外观图/DIMENSION (单位/UNIT : mm)					A	9.2 ±0.3
					B	6.0 ±0.3
					C	5.0 ±0.3
					D	2.54 ±0.2
					E	1.0 TYP
					F	5.7 REF

二.注意事项/NOTE :	三.电路图/CIRCUIT DIAGRAM
1.印字：白色字体.	

四.电气特性/ELECTRICAL CHARACTERISTIC					
品名 Part Number	电感量 Inductance	额定电压 (V) MAX	直流电阻 DC Resistance	额定电流 Current Rating	绝缘阻抗 Isolation
CLCM-0905C-251	250uH +50%/-50%	80V	0.13Ω Max	1.2A	500VAC/3mA/3s

1. Inductance tested at 100 kHz, 0.1 V_{rms}, 0 A_{dc} using an Agilent/HP 4263B LCR meter or equivalent.
 2. The maximum DC current occurs when its temperature rise reaches 40°C.

客户名称 CUSTOMER		客户品名 CUSTOMER P/N	930101 (744224)	版别 REV.	B版
产品类型 PRODUCT TYPE	贴片共模电感	富安品名 OURS P/N	FACM-0905C-251	文件编号 FILE NO.	SP-1701020

五.材料清单/MATERIAL LIST

NO.	ITEM	DESCRIPTION	SUPPLIER
1	CORE	T 3.9*2.0*1.50-PC	DAYE OR EQ
2	CASE	SC-0186	SHUO CHENG OR EQ
3	WIRE	P180 Grd1	ELEKTRISOLA OR EQ
4	EPOXY	E-XNR3614	CHANGLAI OR EQ
5	SOLDER	Sn99.3:Cu0.7	SHENMAO OR EQ
6	INK	WHITE	BON MARQUE OR EQ

六.编带规格/TAPING SPECIFICATIONS

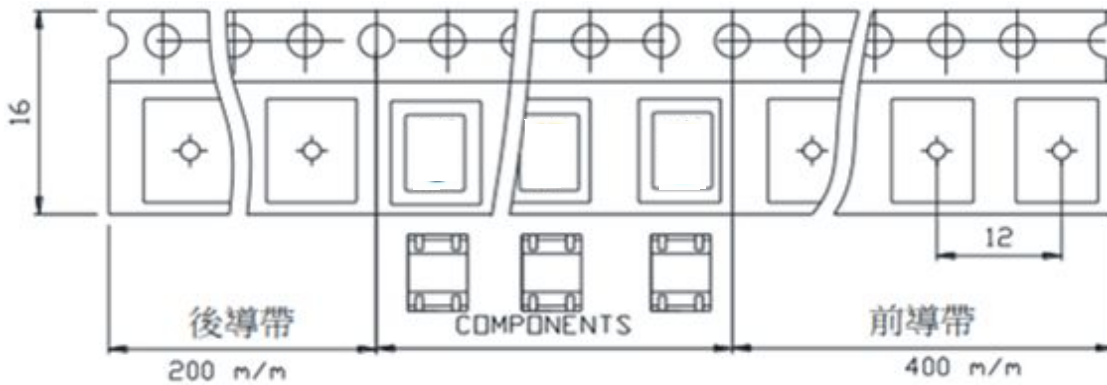

Transparent carrier and cover tape/透明载带和自粘上带

Adhesive strength of cover tape is 20 to 120 gf
The conduction band direction

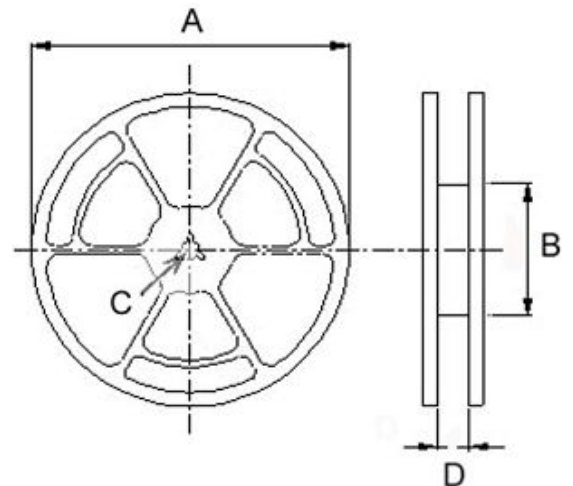
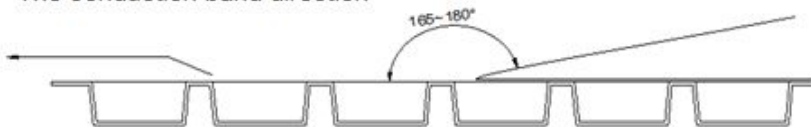

Reel Dimensions (Unit: mm)				Quantity
A	B	C	D	Pcs/Reel
330	100	13	16.5	1000

客户名称 CUSTOMER		客户品名 CUSTOMER P/N	930101 (744224)	版别 REV.	B版
产品类型 PRODUCT TYPE	贴片共模电感	富安品名 OURS P/N	FACM-0905C-251	文件编号 FILE NO.	SP-1701020

八.可靠性测试/RELIABILITY TESTING

Operating Temperature	- 40 to +125 °C (Contain Heating coil)
Appearance Inspection	No external defects by visual inspection
Terminal Strength	After soldering , between copper plaet and terminals of coils , push in two directions of X , Y with standing 10N(1.02kg) for10+/-2 sec. Terminal should not peel off. (Refer to figure at right)
Heat endurance of reflow soldering	Refer to figure
Insulating resistance	Over 100 MΩ at 100V D.C . between wire and core
Dielectric Strength	Apply at 0.5KV 3mA for 1 minute between wire and core
Temperature characteristics	Inductance coefficient (0~2,000) × 10 / °C (- 40~ + 125 °C)
Humidity characteristics	Inductance deviation within ± 10% , after 96 hours in 90~95% relative humidity at 40 ± 2 °C and 1 hours drying under normal condition

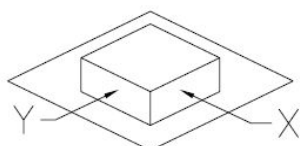

A test is made under the above mentioned condition , and it is kept for 2 hours in the normal

IR Reflow profile

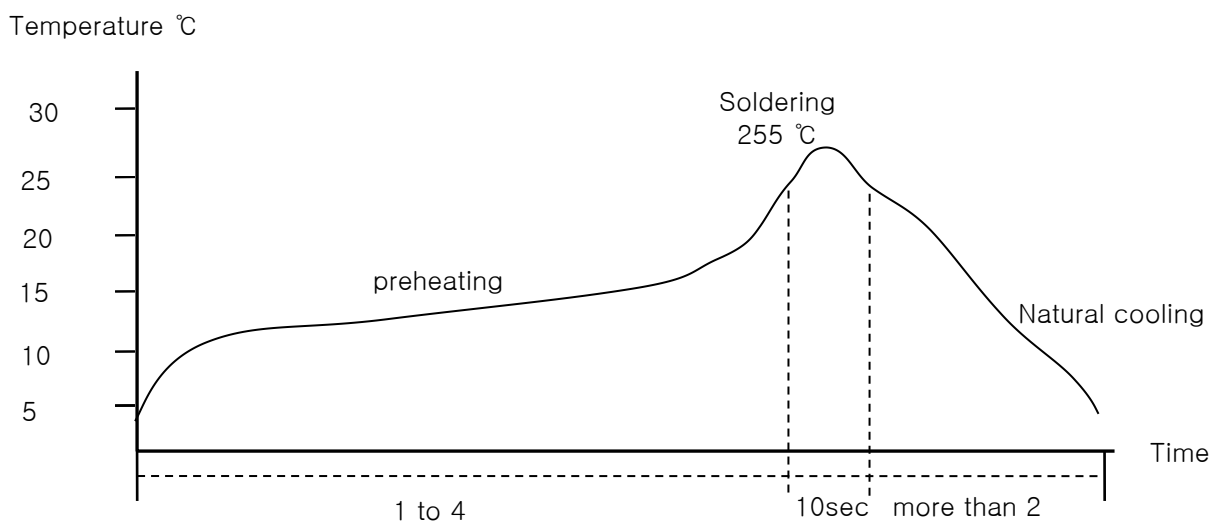

Temperature and humidity . After that , no mechanical and electrical defect should be

客户名称 CUSTOMER		客户品名 CUSTOMER P/N	930101 (744224)	版别 REV.	B版
产品类型 PRODUCT TYPE	贴片共模电感	富安品名 OURS P/N	FACM-0905C-251	文件编号 FILE NO.	SP-1701020

九.包装方式/PACKING LIST

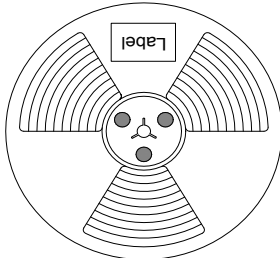
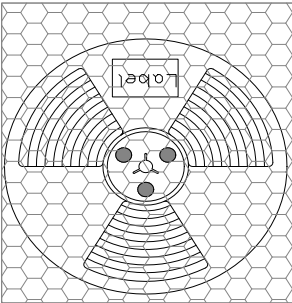
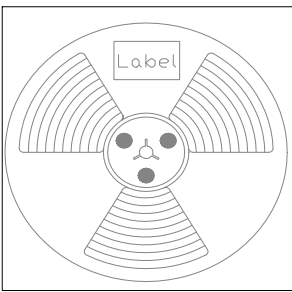
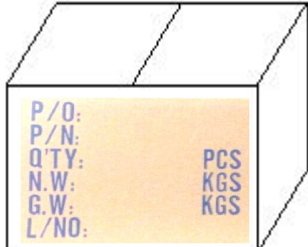
	<p>1、轮盘规格：13'(直径330mm) 数量：1000PCS/盘</p>
	<p>2、数量：1000PCS/袋.</p>
	<p>3、数量：3000PCS/盒</p>
	<p>4、数量：15000PCS/箱. 作业说明：当尾数箱不足一整箱时需用内盒或填充物装满.</p>