

1. Outline Dimensions(Unit:mm)

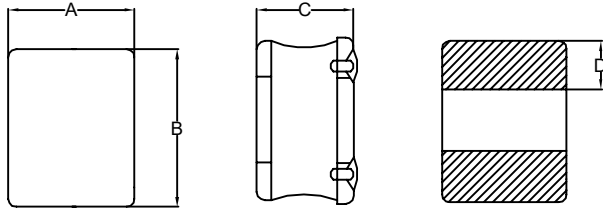

DIM	MILLIMETERS (Units:mm)
A	2.0+0.35/-0.1
B	2.5+0.3/-0.1
C	1.35 Max
D	0.8 REF
E	

2. Electronical Schematic

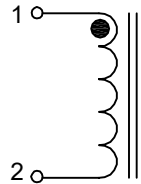

3. Suggested Pad layout

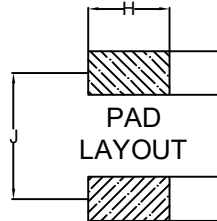

DIM	MILLIMETERS (Units:mm)
H	2.40 Typ
I	1.05 Typ
J	0.80 Typ

4.Recommended solderability temperature profile

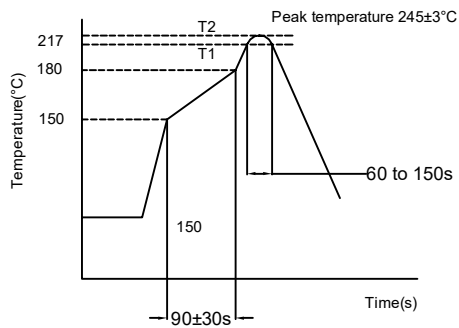

Use rosin-based flux
 Don't use high acidic flux with halide content exceeding 0.2(wt%)(chlorine conversion value).
 Use lead-free solder, use Sn-3.0Ag-0.5Cu solder
 Standard thickness of solder paste:0.12-0.15mm.

REV	ECN.NO	DESCRIPTION	APPD	DATE

5. Electrical Characteristics @25°C

Inductance @100KHz,1V	DCR(Max)	I rms Max	I sat Typ
1.5uH±30%	0.126Ω	1.45A	1.8A

- ※) The saturation current value (I_{dc1}) is the DC current value having inductance decrease down to 30%. (at 20°C)
- ※) The temperature rise current value (I_{dc2}) is the DC current value having temperature increase up to 40°C TYP. (at 20°C)
- ※) The rated current as listed is either the saturation current (I_{dc1}) or the temperature rise current (I_{dc2}) depending on which value is lower.
- ※) Operating temp : -40° to +125°C.
- ※) Storage Temperature:-40 °C to +125 °C

6. Inductance VS Current:

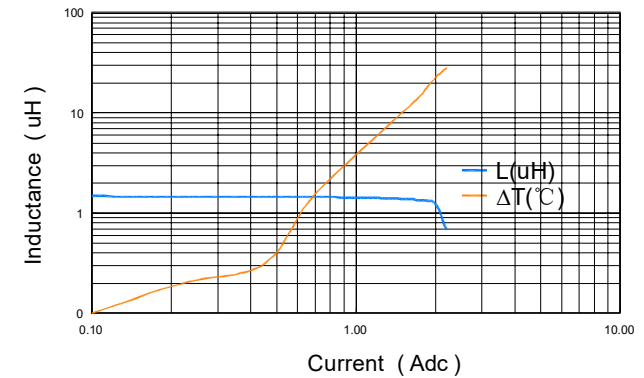

TOLERANCE LEVEL		天長市富安电子有限公司 Tianchang Fuan Electronic Co.,Ltd			
X.	—	DWN:	Benson.zhan	PART NO:	FANR252012-1R5N1R8
.X	—	CHKD:	Anson.zhan	TITLE:	POWER INDUCTOR
.XX	—	APPD:	Louis.Lin	UNITS	mm
.XXX	—	Document is the property of FUAN Inc & is not allow to be duplicated without authorization		SCALE	1:1
				SHEET	1/3
				REV.	A0

7. Reliability Testing.

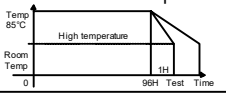
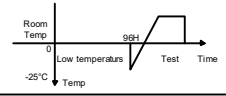
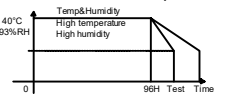
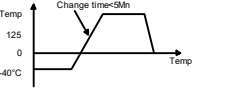
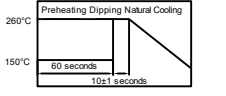
Ltem	Specified value	Test methods
1 High temperature Storage test Reference documents: MIL-STD-202G Method 108A	1.No case deformation or change in appearance. 2. $\Delta L/L \leq 10\%$. 3. $\Delta Q/Q \leq 30\%$. 4. $\Delta DCR/DCR \leq 10\%$.	Temperature: $85 \pm 2^\circ\text{C}$ Time: 96 ± 2 hours. Tested not less than 1 hour, not more than 2 hours at room temperature. 
2 Low temperature Storage test. Referencedocuments: IEC 68-2-1A 6.1 6.2	1.No case deformation or change in appearance. 2. $\Delta L/L \leq 10\%$. 3. $\Delta Q/Q \leq 30\%$. 4. $\Delta DCR/DCR \leq 10\%$.	Temperature: $25 \pm 2^\circ\text{C}$ Time: 96 ± 2 hours. Tested not less than 1 hour, not more than 2 hours at room temperature. 
3 Humidity test Reference Documents: MIL-STD-202G Method 103B	1.No case deformation or change in appearance. 2. $\Delta L/L \leq 10\%$. 3. $\Delta Q/Q \leq 30\%$. 4. $\Delta DCR/DCR \leq 10\%$.	1.Dry oven at a temperature of $40 \pm 5^\circ\text{C}$ for 24 hours. 2.Measurements At the end of this period 3.Exposure: Temperature: $40 \pm 2^\circ\text{C}$, Humidity: $93 \pm 3\% \text{RH}$ Time: 96 ± 2 hours. 4. Tested while the specimens are still in the chamber. 5. Tested not less than 1 hour, nor more than 2 hours at room temperature. 
4 Thermal shock test Reference documents: MIL-STD-202G Method 107G	1.No case deformation or change in appearance. 2. $\Delta L/L \leq 10\%$. 3. $\Delta Q/Q \leq 30\%$. 4. $\Delta DCR/DCR \leq 10\%$. For T: weight $\leq 28\text{g}$: 15 Min $28\text{g} \leq \text{weight} \leq 136\text{g}$: 30 Min	First 40°C for T time, next $+125^\circ\text{C}$ T time as 1 cycle. Go through 20 cycles. 
5 Solderability test Reference documents: MIL-STD-202G Method 208H IPC J-STD-002B	Terminals area must have 95% Min. Solder coverage.	Dip pads in flux then dip in solder pot at $245 \pm 5^\circ\text{C}$ for 5 second. Soler: Sn(93.5)Ag(3.5). Flux: Rosin flux.
6 Heat endurance of Reflow soldering	1.No case deformation or change in appearance. 2. $\Delta L/L \leq 10\%$. 3. $\Delta Q/Q \leq 30\%$. 4. $\Delta DCR/DCR \leq 10\%$.	Preheat: 150°C , 60 second. Solder: Sn/Ag/Cu. Solder: Temperature: $260 \pm 5^\circ\text{C}$. Flux: Rosin flux. Reflow peak time 10 second at 260°C 

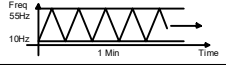
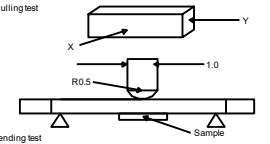
7 Vibration test Reference documents: MIL-STD-202G Method 201A	1.No case deformation or change in appearance. 2. $\Delta L/L \leq 10\%$. 3. $\Delta Q/Q \leq 30\%$. 4. $\Delta DCR/DCR \leq 10\%$.	Apply frequency 10~55Hz. 0.75mm amplitude in each of perpendicular direction for 2 hours.(total 6 hours). 
8 Drop test Reference documents: MIL-STD-202G Method 203G	1.No case deformation or change in appearance. 2. $\Delta L/L \leq 10\%$. 3. $\Delta Q/Q \leq 30\%$. 4. $\Delta DCR/DCR \leq 10\%$. For T: weight $\leq 28\text{g}$: 15 Min $28\text{g} \leq \text{weight} \leq 136\text{g}$: 30 Min	Packaged & Drop down from 1m with 981 m/s^2 (100G) attitude in 1 angle 1 ridges & 2 surfaces orientations.
9 Terminal strength push test Reference documents: JIS C 5321:1997	Pulling test: DEFINE:A:sectional area of terminal $A \leq 8(\text{Sq M})$ Force $\geq 5\text{N}$ time: 30sec $8(\text{Sq M}) < A \leq 20(\text{Sq M})$ Force $\geq 10\text{N}$ time: 10sec $20(\text{Sq M}) < A$ force $\geq 20\text{N}$ time: 10sec Bending test: Soldering the products on PCB, after the pulling test and bending test, terminal should not pull off	Bend the testing PCB at middle point, the deflection shall be 2mm 
10 Resistance to solvent test Reference documents: IEC 68-2-45:1993	No case deformation or change in appearance, or obliteration of marking	To dip parts into IPA solvent for 5 ± 0.5 Min, then drying them at room temp for 5 Min, at last, to brushing making 10 times.
11 Electronic characteristic test of major products	Refer to catalogue of specific products	Refer to catalogue of specific products
12 Overload test Reference documents:	1. During the test no smoke, no peculiar, smell, no fire	Apply twice as rated current for 5 minutes.

TOLERANCE LEVEL		天市长富安电子有限公司 Tianchang Fuan Electronic Co.,Ltd				
.X	—	DWN: Benson.zhan	PART NO: FANR252012-1R5N1R8			
.X	—		TITLE: POWER INDUCTOR			
.XX	—	CHKD: Anson.zhan	UNITS	SCALE	SHEET	REV.
.XXX	—		mm	1:1	2/3	A0
Document is the property of FUAN Inc & is not allow to be duplicated without authorization		APPD: Louis.Lin				

8. Packaging

2000PCS/Reel

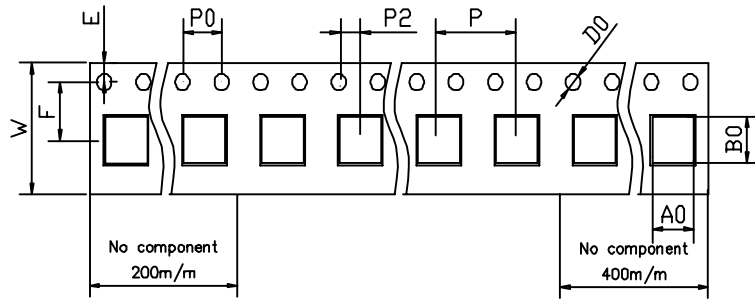

A0	2.40	F	3.5
B0	2.80	P	4.0
D0	1.5	P0	4.0
D1		P2	2.0
E	1.75	W	8.0

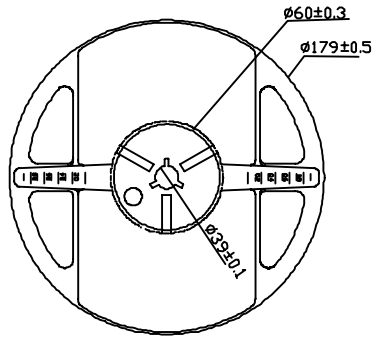

TOLERANCE LEVEL		天長市富安電子有限公司 Tianchang Fuan Electronic Co.,Ltd				
x.	—	DWN: Benson.zhan	PART NO: FANR252012-1R5N1R8			
.X	—		TITLE: POWER INDUCTOR			
.XX	—	CHKD: Anson.zhan				
.XXX	—	APPD: Louis.Lin	UNITS	SCALE	SHEET	REV.
Document is the property of FUAN Inc & is not allow to be duplicated without authorization			mm	1:1	3/3	A0

1
2
3
4
5
6