



Coilmaster



RoHS Compliant

SPECIFICATION APPROVAL

CUSTOMER : Devetech

PRODUCT : MI3216-601-3A-LF

Pb-free

CODE NO. : C01432066

CUS. CODE :

SPEC.NO. : C-1432-066(00)

DATE : 21-Apr-15

CUSTOMER APPROVAL

Coilmaster Electronics Co., Ltd.

9F-3,NO.398 HUAN BEI ROAD, CHUNG-LI CITY

TAOYUAN HSIEN, TAIWAN, R.O.C.

TEL : (886)34228279 FAX : (886)34228734

PREPARED BY	APPROVED BY	AUTHORIZED BY
JEAN	TONY	MASCOT

PRODUCT	MI3216-601-3A-LF	COIL SPECIFICATION	DATE	2015/4/21
SPEC.NO.	C-1432-066(00)		CODE NO.	C01432066

CONFIGURATION & DIMENSIONS :

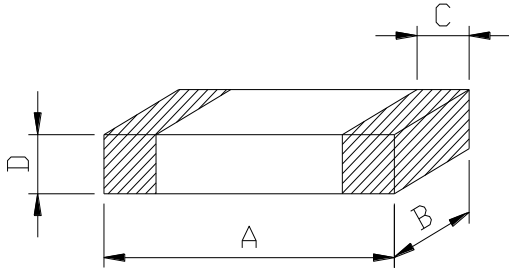

A	: 3.2±0.2	m/m
B	: 1.6±0.2	m/m
C	: 0.4~1.0	m/m
D	: 1.1±0.2	m/m

ELECTRICAL CHARACTERISTIC :

IMPEDANCE (Ω) AT 100 MHz 100mV :	600±25%
DC RESISTANCE(Ω) :	0.06 Max.
RATED CURRENT (mA) :	3000 Max.
Operating temperature :	-55°C + 125°C

STANDARD ATMOSPHERIC CONDITIONS

Unless otherwise specified the standard range of atmospheric conditions for making measurements and tests is as follows:

Ambient temperature : 20±15°C

Relative humidity : 30%~70%

If there may be any doubt on the results, measurements shall be made within the following limits :

Ambient temperature : 25±5°C

Relative humidity : 30%~70%

PRODUCT	MI3216-601-3A-LF	COIL SPECIFICATION	DATE	2015/4/21
SPEC.NO.	C-1432-066(00)		CODE NO.	C01432066

Impedance vs Frequency Curve

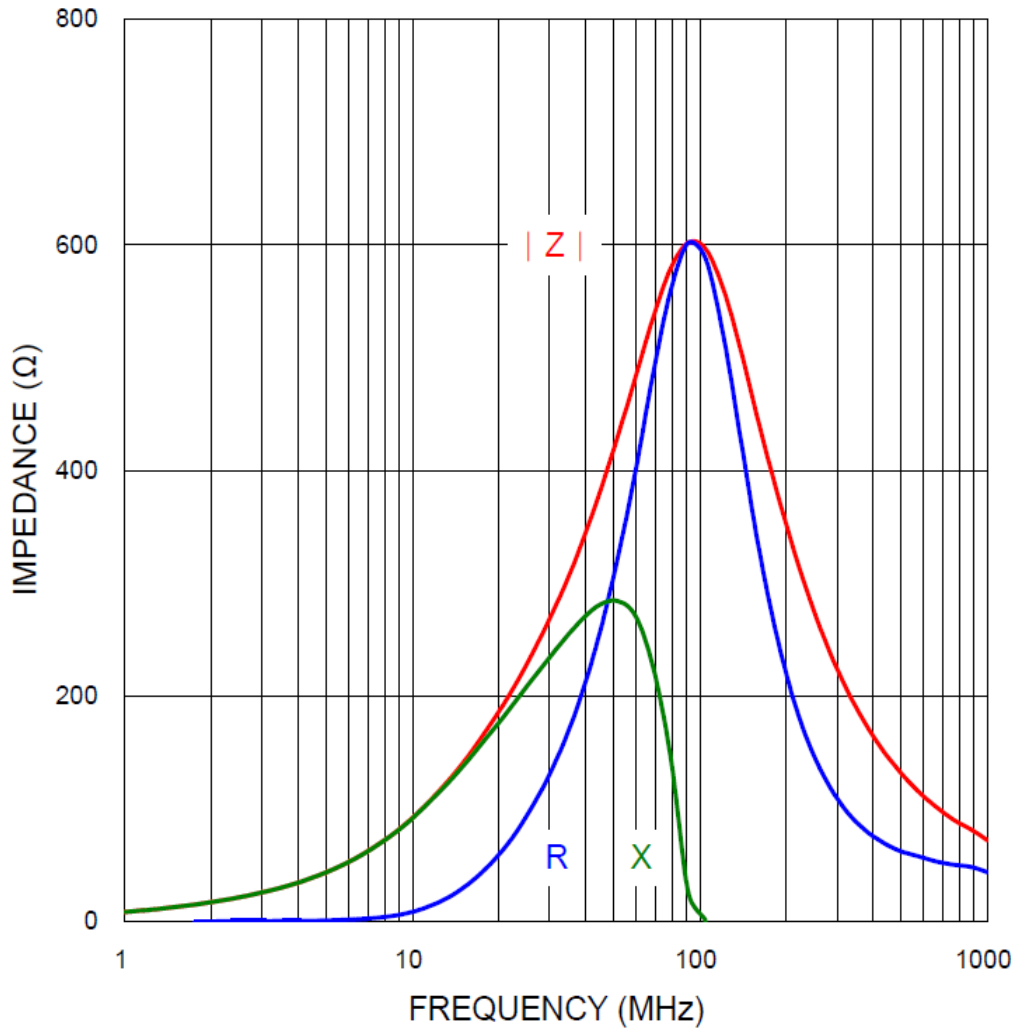

COILMASTER ELECTRONICS CO., LTD.

PRODUCT	MI3216-601-3A-LF	COIL SPECIFICATION	DATE	2015/4/21
SPEC.NO.	C-1432-066(00)		CODE NO.	C01432066

6) Reflow soldering conditions

- Pre-heating should be in such a way that the temperature difference between solder and ferrite surface is limited to 150°C max. Also cooling into solvent after soldering should be in such a way that the temperature difference is limited to 100°C max.

Unenough pre-heating may cause cracks on the ferrite, resulting in the deterioration of product quality.

- Products should be soldered within the following allowable range indicated by the slanted line.

The excessive soldering conditions may cause the corrosion of the electrode, When soldering is repeated, allowable time is the accumulated time.

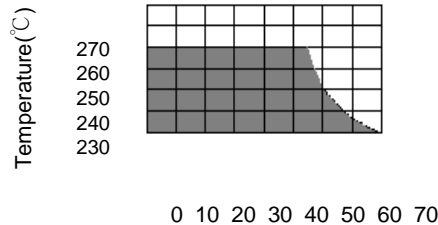

Temperature Profile

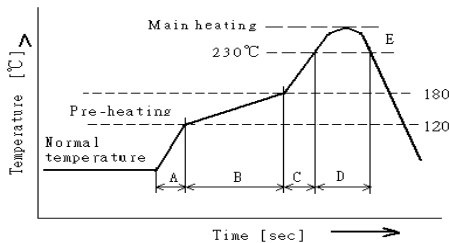

A	Slope of temp. rise	1 to 5	°C/sec
B	Heat time	50 to 150	sec
	Heat temperature	120 to 180	°C
C	Slope of temp. rise	1 to 5	°C/sec
D	Time over 230°C	90~120	sec
E	Peak temperature	255~260	°C
	Peak hold time	10 max.	sec
*No. of mounting		3	times

(Melting area of solder)

6-1 Reworking with soldering iron

Preheating	150°C, 1minute
Tip temperature	280°C max
Soldering time	3seconds max.
Soldering iron output	30w max.
End of soldering iron	∅ 3mm max.

- Reworking should be limited to only one time.

Note : Do not directly touch the products with the tip of the soldering iron in order to prevent the crack on the ferrite material due to the thermal shock.

6-2 Solder Volume

Solder shall be used not to be exceed the upper limits as shown below.

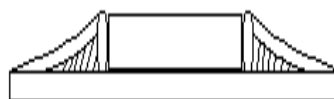

Accordingly increasing the solder volume, the mechanical stress to product is also increased. Exceeding solder volume may cause the failure of mechanical or electrical performance.

PRODUCT	MI3216-601-3A-LF	COIL SPECIFICATION	DATE	2015/4/21
SPEC.NO.	C-1432-066(00)		CODE NO.	C01432066

7 EQUIPMENT

7-1 IMPEDANCE

Impedance shall be measured with HP – 4286A impedance analyzer or equivalent system

7-2 DC RESISTANCE

DC resistance shall be measured using HP 4338 digital mili – ohm meter with 4 terminal method.

8.MECHANICAL CHARACTERISTICS

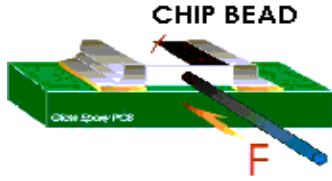
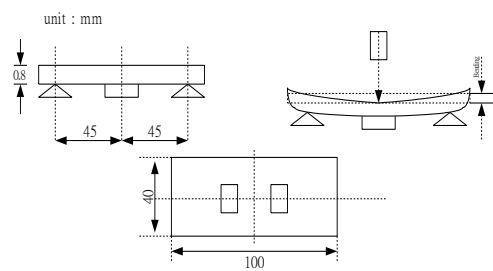
ITEM	Specification	TEST CONDITIONS
TERMINAL STRENGTH	Without deformation cases impedance shall be satisfied $\pm 30\%$ DC resistance shall be satisfied.	Solder chip on PCB and applied 10N (1.02Kgf) for 10 sec 
Substrate bending test	Without deformation cases, impedance shall be satisfied $\pm 30\%$ DC resistance shall be satisfied.	After soldering a chip to a test substrate, bend the substrate by 3mm hold for 10s and then return. Soldering shall be done in accordance with the recommended PC board pattern and reflow soldering. 
RESISTANCE TO SOLDER HEAT	No visible damage Electrical characteristics and mechanical characteristics shall be satisfied.	Solder Temp. : $265\pm 3^{\circ}\text{C}$ Immersion time : 6 ± 1 sec Preheating : 100°C to 150°C , 1 minute. Measurement to be made after keeping at room temp for 24 ± 2 hrs. Solder : Sn-3Ag-0.5Cu
SOLDER – ABILITY	95% min. coverage of all metallized area	Solder temp. : $240\pm 5^{\circ}\text{C}$ Immersion time : 3 ± 1 sec Solder : Sn-3Ag-0.5Cu

PRODUCT	MI3216-601-3A-LF	COIL SPECIFICATION	DATE	2015/4/21
SPEC.NO.	C-1432-066(00)		CODE NO.	C01432066

9. RELIABILITY AND TEST CONDITIONS

9-1 HIGH TEMPERATURE RESISTANCE

a. Performance specification

1. Appearance : no mechanical damage
2. Impedance shall be with $\pm 30\%$ of the initial value
3. DC resistance shall be satisfied

b. Test condition

1. Temperature $125^{\circ}\text{C} \pm 2^{\circ}\text{C}$
2. Applied current : Rated current (maximum value)
3. Testing time : 96 ± 4 hrs
4. Measurement : After placing at room ambient temperature for 1 hours minimum

9-2 HUMIDITY RESISTANCE

a. Performance specification

1. Appearance : no mechanical damage
2. Impedance: within $\pm 30\%$ of initial value
3. DC resistance shall be satisfied

b. Test condition

1. Humidity : 90 to 95% RH
2. Temperature : $60 \pm 2^{\circ}\text{C}$
3. Applied current : Rated current (maximum value)
4. Testing time : 500 ± 4 hours
5. Measurement : After placing at room ambient temperature for 1 hours minimum

9-3 TEMPERATURE CYCLE

a. Performance specification

1. Appearance : no mechanical damage
2. Impedance: within $\pm 30\%$ of initial value
3. DC resistance shall be satisfied

b. Test condition

1. Temperature $-55^{\circ}\text{C}, +125^{\circ}\text{C}$ kept stabilized for 30 minutes each
2. Cycle : 100 cycles
3. Measurement : After placing for 1 hours minimum at room ambient temperature
4. step1. -55°C temp $\pm 3^{\circ}\text{C}$ 30 ± 3 minutes
step2. Standard atmospheric conditions 5s or less
step3. $+125^{\circ}\text{C}$ temp $\pm 2^{\circ}\text{C}$ 30 ± 3 minutes
step4. Standard atmospheric conditions 5s or less

9-4 LOW TEMPERATURE STORAGE LIFE TEST

a. Performance specification

1. Appearance : no mechanical damage
2. Impedance shall be with $\pm 30\%$ of the initial value
3. DC resistance shall be satisfied

b. Test condition

1. Temperature $-55^{\circ}\text{C} \pm 2^{\circ}\text{C}$
2. Testing time : 1008 ± 12 hours
3. Measurement : After placing for 24 hours minimum at room ambient temperature

COILMASTER ELECTRONICS CO., LTD.

PRODUCT	MI3216-601-3A-LF	COIL SPECIFICATION	DATE	2015/4/21
SPEC.NO.	C-1432-066(00)		CODE NO.	C01432066

EMBOSSED CARRIER TAPE PACKAGING

1 DIMENSIONS

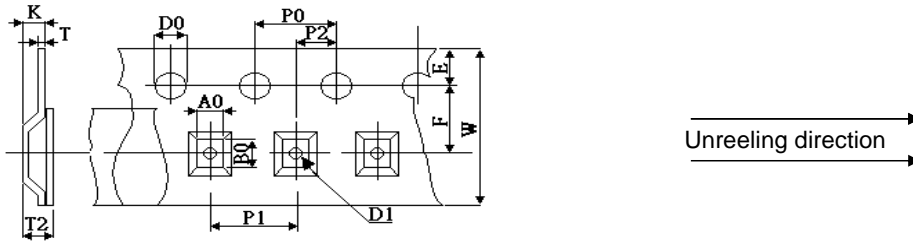

A0	B0	W	F	E	P1	P2	P0	D0	T	T2
1.78	3.4	8.0	3.5	1.75	4.0	2.00	4.0	1.55	0.23	1.29
±0.1	±0.1	±0.2	±0.05	±0.1	±0.1	±0.05	±0.1	±0.05	±0.1	±0.1

2 LEADER AND TRAILER TAPE

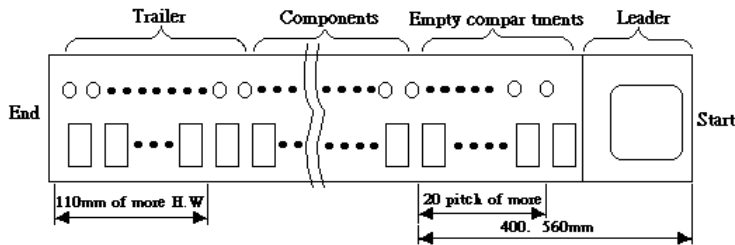

3 DIRECTION THE DIRECTION SHALL BE SEEN FROM THE TOP OF COVER TAPE



4 REELS

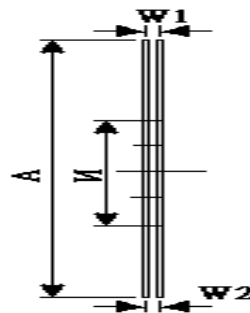
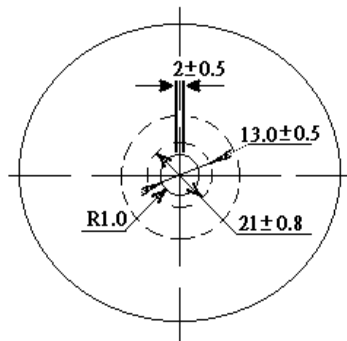

UNIT:mm

A	178 ±2.0
N	50 MIN
W1	10 ±1.5
W2	20 MAX

PACKING QTY.

3,000 PCS REEL

COILMASTER ELECTRONICS CO., LTD.

PRODUCT	MI3216-601-3A-LF	COIL SPECIFICATION	DATE	2015/4/21
SPEC.NO.	C-1432-066(00)		CODE NO.	C01432066

10-5 PULLING STRENGTH OF TAPES

Carrier tape	(1kgf or more)
Cover tape	(0.5kgf or more)

10-6 PEELING STRENGTH OF COVER TAPE

Cover tape	(20g~120g)
------------	------------

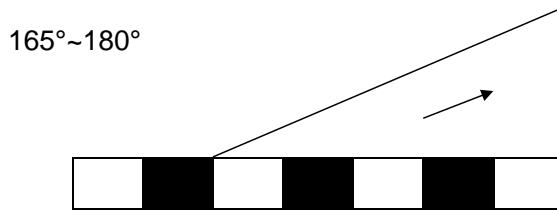

Test condition

- 1) peel angle : 165°~180° vs carrier tape
- 2) peel speed : 300mm/min

11.PACKAGING

- 1) Tape & Reel packaging in composite specification 6/8
- 2) Reel and a bag of desiccant shall be packed in Nylon or plastic bag
- 3) Maximum of 5 bags shall be packaged in a inner box
- 4) Maximum of 6 inner box shall be packaged in a outer box

12.Reel Label

Producing the goods label needs to indicate (1) Pb Free (2) RoHS Compliant

PRODUCT	MI3216-601-3A-LF	COIL SPECIFICATION	DATE	2015/4/21
SPEC.NO.	C-1432-066(00)		CODE NO.	C01432066

12. STORAGE

12-1 The solderability of the external electrode may be deteriorated if packages are stored where they are exposed to high humidity. Packages must be stored at 40°C or less and 70% RH or less.

12-2 The solderability of the external electrode may be deteriorated if packages are stored where they are exposed to dust or harmful gas (hydrogen chloride, sulfurous acid gas or hydrogen sulfide).

12-3 Packaging material may be deformed if packages are stored where they are exposed to heat or direct sun — light.

12-4 Minimum packages, such as polyvinyl heat — seal packages shall not be opened until just before they are used.
If opened, use the reels as soon as possible.

12-5 Solderability specified in composite specification 4/8 shall be for 6 months from the date of delivery on condition that they are stored at the environment specified clause 12-1 & 12-2.

For those parts which passed more than 6 months shall be checked solderability before it is used.

PRODUCT	MI3216-601-3A-LF	COIL SPECIFICATION	DATE	2015/4/21
SPEC.NO.	C-1432-066(00)		CODE NO.	C01432066

TABLE :

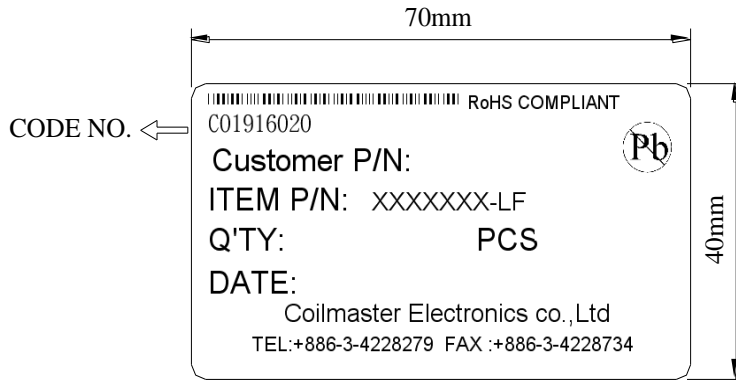

INNER BOX LABEL

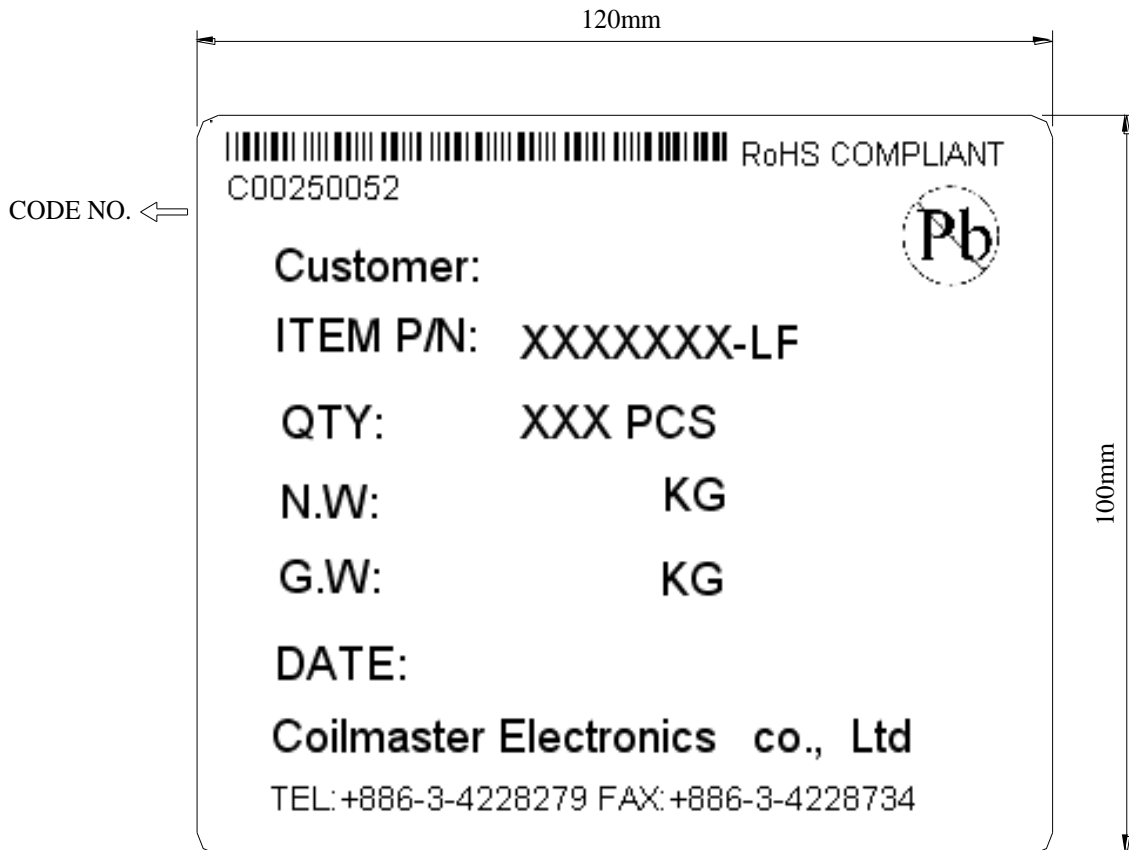

OUT BOX LABEL

COILMASTER ELECTRONICS CO., LTD.