

APEX

APEX SCIENCE & ENGINEERING CORP

(OPTOELECTRONIC DIV.)



新北市中和區新民街 112 號 4 樓 Http : www.apexgroup.com.tw
4F, No. 112, Shin - Min St., Chung Ho Dist., New Taipei City 235, Taiwan, R.O.C.
Tel : 886 - 2 - 2228 - 7331 Fax : 886 - 2 - 2221 - 9105

TAD84301HFR70N

ROHS

DATA SHEET

Acceptance

ISSUE	VERSION	APPROVER	CHECKER	ENGINEER
	A			

Messrs.			
Product Specification	Model:	TAD84301HFR70N	Rev. NO.
			A
			Issued Date.
			APR.09,19

Table of Contents

Table of Contents.....	2
Record of Revision.....	3
1 General Specifications.....	4
2 Input/Output Terminals.....	5
3 Absolute Maximum Ratings.....	6
4 Electrical Characteristics.....	6
5 Timing Chart.....	9
6 Optical Characteristics.....	14
7 Environmental / Reliability Tests.....	17
8 Mechanical Drawing.....	18
9 Packing Drawing.....	19
10 Inspection Criteria.....	21

Messrs.				
Product Specification	Model:	TAD84301HFR70N	Rev. NO.	Issued Date.
			A	APR.09,19

Record of Revision

Revision	Revision Date	Contents	Approved
A	2019/04/09	Initial Release and Issue Full Specification	Kevin

Messrs.			
Product Specification	Model:	TAD84301HFR70N	Rev. NO.
			A
			Issued Date.
			APR.09,19

1 General Specifications

Feature		Spec
Display Spec.	Size	4.3 inch
	Resolution	480xRGBx272
	Interface	RGB 24bit
	Color Depth	16.7M
	Technology Type	IPS
	Pixel pitch(mm)	0.198x0.198
	Pixel Configuration	R.G.B Vertical Stripe
	Display Mode	Transmissive/Normally Black
	Surface Treatment	Glare
	Viewing Direction	ALL
Mechanical Characteristics	LCM (W x Lx H) (mm)	105.50x67.20x2.8
	Active Area(mm)	95.04x53.86
	Driver IC	SC7283
	With /Without TSP	Without TSP
	Weight (g)	38.5
	LED Numbers	10LEDs

Note 1: Requirements on Environmental Protection: RoHS

Note 2: LCM weight tolerance: $\pm 5\%$

Note 3: The main FPC and plastic frame can fulfill UL94-V0

Messrs.				
Product Specification	Model:	TAD84301HFR70N	Rev. NO.	Issued Date.
			A	APR.09,19

2 Input/Output Terminals

2.1 TFT LCD Panel

No	Symbol	I/O	Description	Comment
1	LED-	P	LED cathode	
2	LED+	P	LED anode	
3	GND	P	Ground	
4	VDD	P	Power supply	
5~12	R0~R7	I/O	Red data0~7	
13~20	G0~G7	I/O	Green data0~7	
21~28	B0~B7	I/O	Blue data0~7	
29	GND	P	Ground	
30	PCLK	I	Clock signal; latching data at the falling edge	
31	DISP	I	Display control / standby mode selection. DISP = "Low" : Standby; (Default) DISP = "High" : Normal display	
32	HSYNC	I	Horizontal sync signal; negative polarity	
33	VSYNC	I	Vertical sync signal; negative polarity	
34	DE	I	Data input enable. Active High to enable the data input.	
35	NC	-	No connection	
36	GND	P	Ground	
37~40	NC	-	No connection	

Note 1: I—Input, O—Output, P—Power/Ground, VDD=VDD

Table 2.1 Terminal pin assignments

- **THE DEFAULT VALUE FOR "ID2 & ID3" of Read Display ID REGISTER IS "89h & F0h" ;**

Messrs.				
Product Specification	Model:	TAD84301HFR70N	Rev. NO.	Issued Date.
			A	APR.09,19

3 Absolute Maximum Ratings

3.1 Driving TFT LCD Panel

Ta =25°C

Item	Symbol	Min.	Typ.	Max.	Unit	Condition	Remark
LC Operating Voltage	VOP	--	-	5.1	V		*1,*2
Operating Temperature	Top	-30	-	85	°C		
Storage Temperature	Tst	-30	-	85	°C		
Operating Ambient Humidity	Hop	10		*4	RH		*3
Storage Humidity	Hst	10	-	*4	RH		*3

Note1:

*1.At 25+/-5°C

*2.Due to the characteristics of LC Material, the Liquid Crystal driving voltage varies with environmental temperature.

*3.Non-condensation

*4.Temp.≤ 60°C,90%RH Max.

Temp. > 60°C,Absolute humidity shall be less than 90%RH.

Table 3.1 absolute maximum rating

4 Electrical Characteristics

4.1 Driving TFT LCD Panel

GND=0V, Ta=25°C

Item	Symbol	Min.	Typ.	Max.	Unit	Note
Supply Voltage	VDD	3.0	3.3	3.6	V	Note2
Supply Voltage	VDDI	3.0	-	3.6	V	Note2
High-level Input Voltage	VIH	0.7* VDDI	-	VDDI	V	Note1,2
Low-level Input Voltage	VIL	DGND	-	0.3* VDDI	V	Note1,2
High-level Output Voltage	VOH	VDDI-0.4	-	VDDI	V	Note1,2
Low-level Output Voltage	VOL	DGND	-	DGND+0.4	V	Note1,2
Supply Current for LED	IF	-	20	-	mA	Each
Sleep Current	Isc	-	-	50	uA	
Display Current	Ioc	-	30	-	mA	

Table 4.1 LCD module electrical characteristics

Note2: Only provide the DVDD,no any data code was sent to display drive IC.

Messrs.			
Product Specification	Model:	TAD84301HFR70N	Rev. NO.
			A
			Issued Date.
			APR.09,19

Backlight Unit

Ta=25°C

Item	Symbol	MIN	TYP	MAX	Unit	Remark
Forward Current	IF	—	40	-	mA	Note 4
Forward Current Voltage	VF	-	15.5	-	V	Note 1,2
Backlight Power Consumption	WBL	—	525	-	mW	For total LEDs
LED lifetime	L	—	30000	—	Hours	Note1,2,3,4

Table 4.2 Backlight Unit electrical characteristics

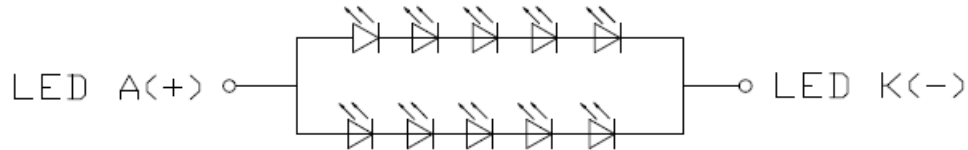

(CIRCUIT DIAGRAM)

IF=40mA, VF=15.5V

Note1: The LED driving condition is defined for each LED module (1 LED Serial, 1 LED Parallel).

Note2: Under LCM operating, the stable forward current should be inputted. And forward voltage is for reference only.

Note3: Optical performance should be evaluated at Ta=25°C only If LED is driven by high current, high ambient temperature & humidity condition. The life time of LED will be reduced. Operating life means brightness goes down to 50% initial brightness. Typical operating life time is estimated data. At the same time the luminance of Backlight would decrease under the high temperature.

Note4: The LED driving condition is defined for each LED module.

Messrs.			
Product Specification	Model:	TAD84301HFR70N	Rev. NO.
			A
			Issued Date.
			APR.09,19

4.2 Block Diagram
LCD module diagram

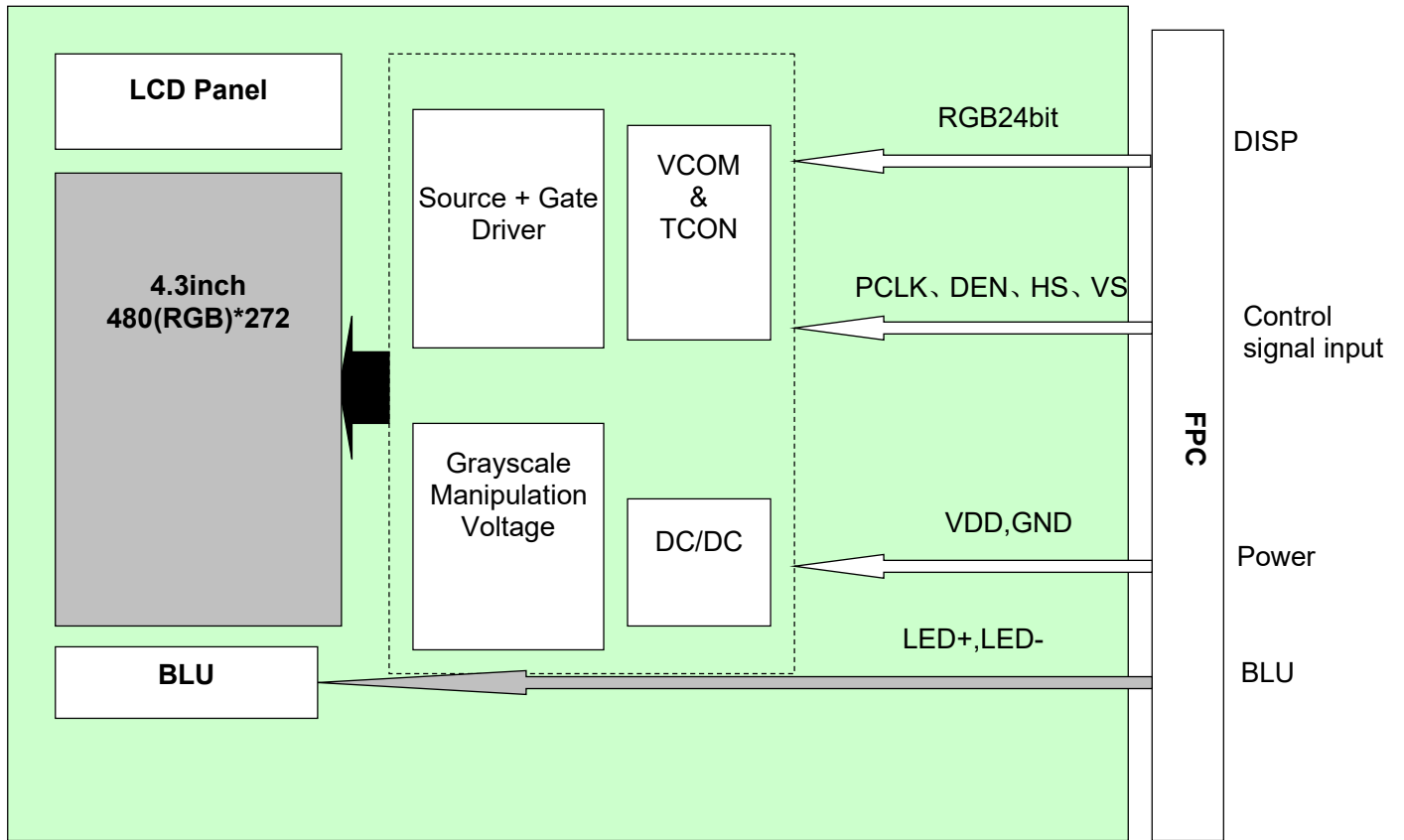

Messrs.			
Product Specification	Model:	TAD84301HFR70N	Rev. NO.
			A
			Issued Date.
			APR.09,19

5. Timing Chart

5.1 INTERFACE TIMING

Note: Please refer to SC7283 data sheet for more details.

SYNC Mode

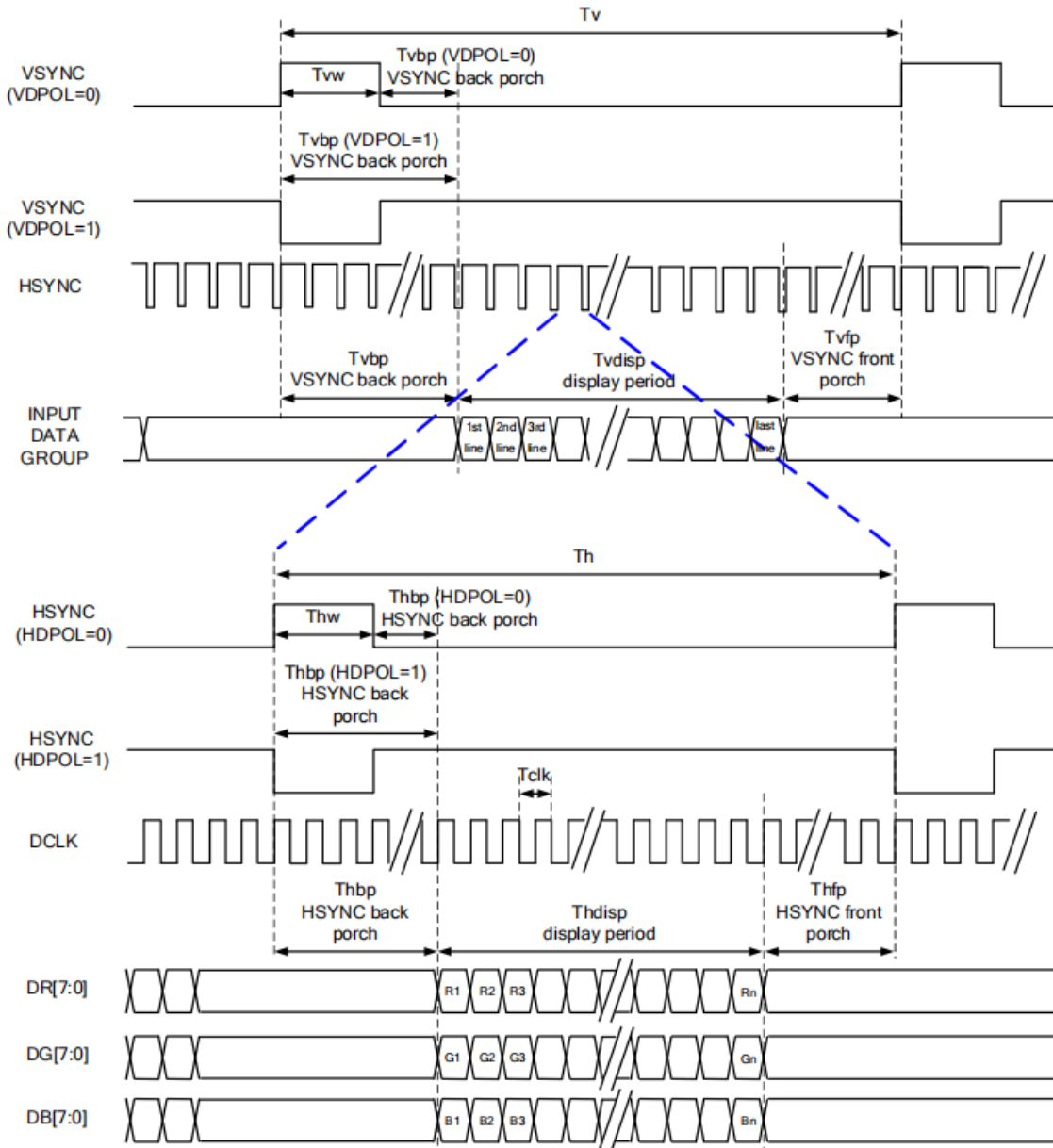

Messrs.			
Product Specification	Model:	TAD84301HFR70N	Rev. NO.
			A
			Issued Date.
			APR.09,19

SYNC-DE Mode

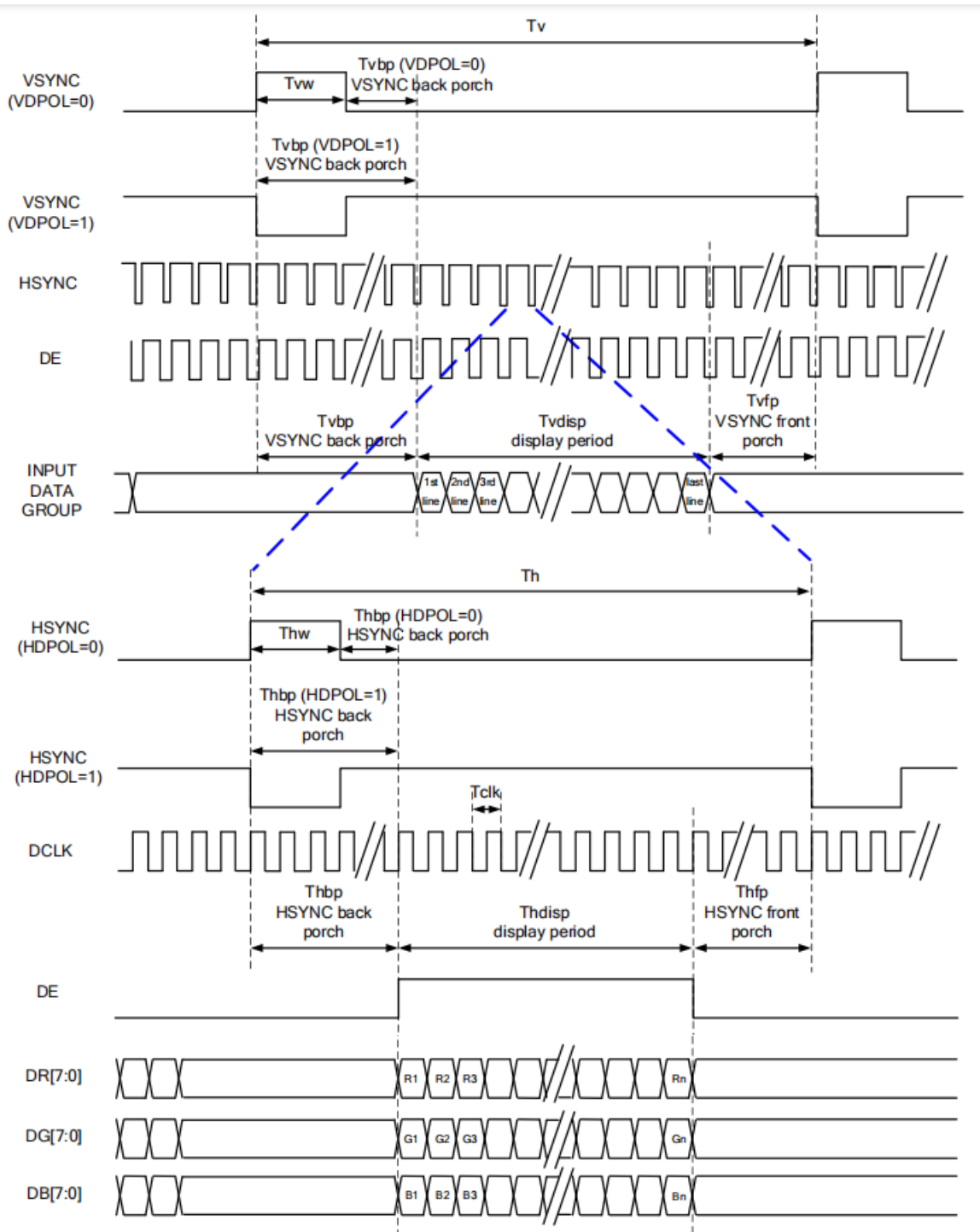

Messrs.			
Product Specification	Model:	TAD84301HFR70N	Rev. NO.
			A
			Issued Date.
			APR.09,19

DE Mode

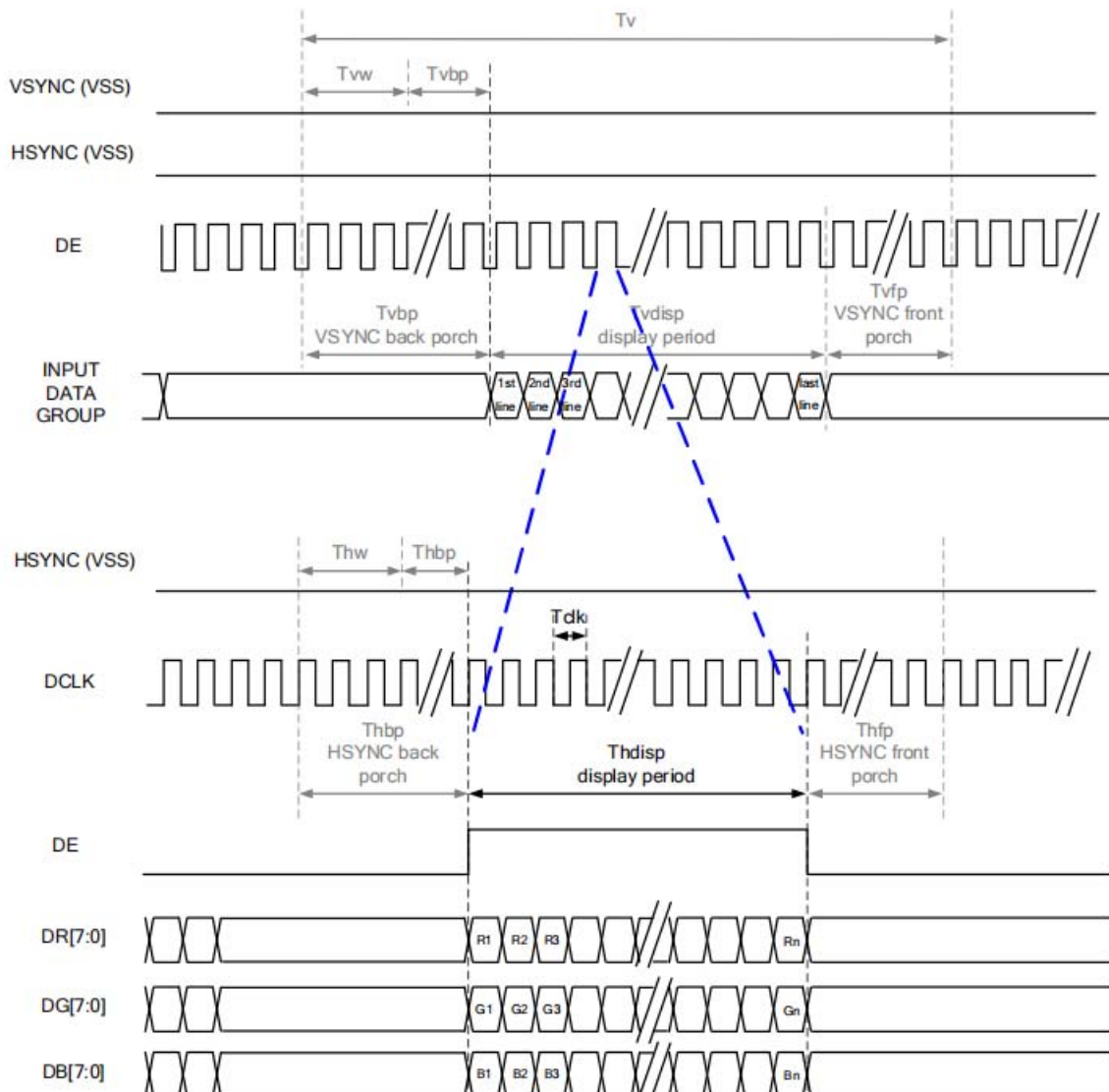

RGB Mode Selection Table	DCLK	HSYNC	VSYNC	DE
SYNC - DE Mode	Input	Input	Input	Input
SYNC Mode	Input	Input	Input	GND
DE Mode	Input	GND	GND	Input

Note: "Input" means these signals are driven by host side.

Messrs.			
Product Specification	Model:	TAD84301HFR70N	Rev. NO.
			A
			Issued Date.
			APR.09,19

7.3.4 Parallel 24 bit RGB Input Timing Table

I 24-bit RGB Input Timing (PVDD=VDD=VDDI= 3.3V, AGND= 0V, TA=25°C)

480RGB X 272 Resolution Timing Table							
Item	Symbol	Min.	Typ.	Max.	Unit	Remark	
DCLK Frequency	Fclk	8	9	12	MHz		
DCLK Period	Tclk	83	111	125	ns		
HSYNC	Period Time	Th	485	531	598	DCLK	
	Display Period	Thdisp		480		DCLK	
	Back Porch	Thbp	3	43	43	DCLK	By H_BLANKING setting
	Front Porch	Thfp	2	8	75	DCLK	
	Pulse Width	Thw	2	4	43	DCLK	
VSYNC	Period Time	Tv	276	292	321	HSYNC	
	Display Period	Tvdisp		272		HSYNC	
	Back Porch	Tvbp	2	12	12	HSYNC	By V_BLANKING setting
	Front Porch	Tvfp	2	8	37	HSYNC	
	Pulse Width	Tvw	2	4	12	HSYNC	

Note: It is necessary to keep Tvbp =12 and Thbp =43 in sync mode. DE mode is unnecessary to keep it.

System Bus Timing for RGB Interface

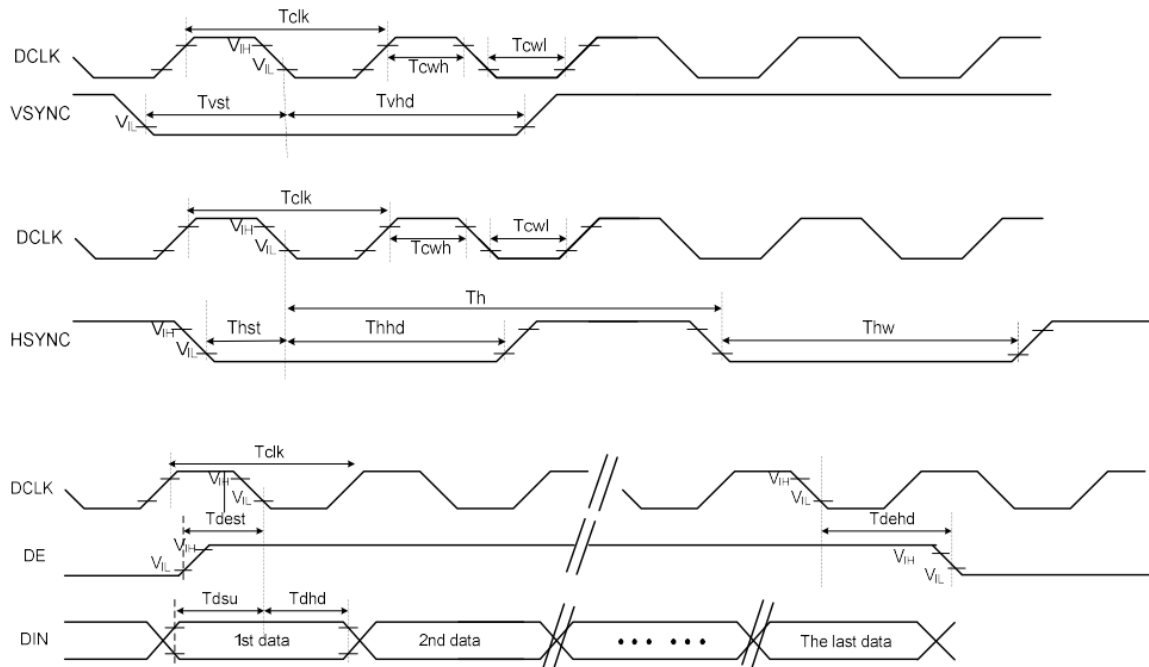

Messrs.			
Product Specification	Model:	TAD84301HFR70N	Rev. NO.
			A
			Issued Date.
			APR.09,19

Item	Symbol	Min.	Typ.	Max.	Unit	Conditions
CLK Pulse Duty	Tcw	40	50	60	%	
HSYNC Width	Thw	2	-	-	DCLK	
HSYNC Period	Th	55	60	65	us	
VSYNC Setup Time	Tvst	12	-	-	ns	
VSYNC Hold Time	Tvhd	12	-	-	ns	
HSYNC Setup Time	Thst	12	-	-	ns	
HSYNC Hold Time	Thhd	12	-	-	ns	
Data Setup Time	Tdsu	12	-	-	ns	
Data Hold Time	Tdhd	12	-	-	ns	
DE Setup Time	Tdest	12	-	-	ns	
DE Hold Time	Tdehd	12	-	-	ns	

Power On Sequence:

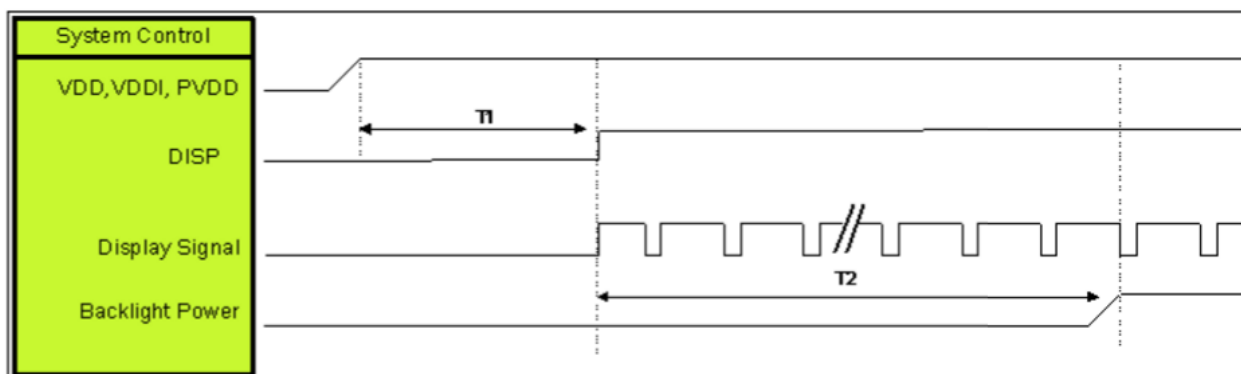

Symbol	Description	Min. Time	Unit
T0	System power stability to GRB RESET signal	0	ms
T2	Display Signal output to Backlight Power on	250	ms

Power Off Sequence:

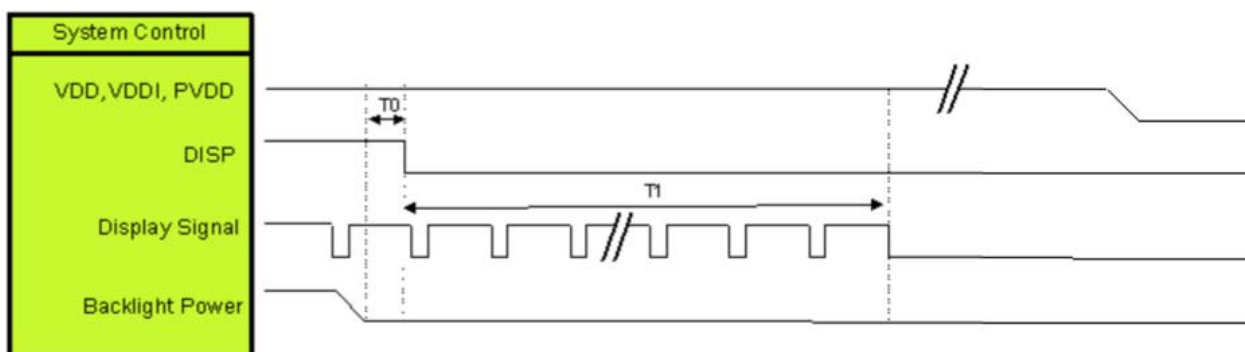

Symbol	Description	Min. Time	Unit
T0	Backlight Power off to DISP="Low"	5	ms
T1	DISP="Low" to IC internal voltage discharge complete	80	ms

Messrs.				
Product Specification	Model:	TAD84301HFR70N	Rev. NO.	Issued Date.
			A	APR.09,19

6 Optical Characteristics

Ta=25°C

Item	Symbol	Condition	Min	Typ	Max	Unit	Remark
View Angles	θT	CR \geq 10	70	80	-	Degree	Note2,3,8
	θB		70	80	-		
	θL		70	80	-		
	θR		70	80	-		
Contrast Ratio	CR	$\theta=0^\circ$	640	800	-		Note 3
Response Time	T _{ON}	25°C	-	30	40	ms	Note 4
	T _{OFF}						
Chromaticity	White	Backlight is on	x	0.2500	0.3000	0.3500	Note 1,5
			y	0.2928	0.3428	0.3928	
	Red		x	0.5500	0.6000	0.6500	Note 1,5
			y	0.3040	0.3540	0.4040	
	Green		x	0.3020	0.3520	0.4020	Note 1,5
			y	0.5300	0.5800	0.6300	
	Blue		x	0.0990	0.1490	0.1990	Note 1,5
			y	0.0682	0.1182	0.1682	
Uniformity	U		80	-	-	%	Note 6
NTSC			45	50	-	%	Note 5
Luminance	L		700	900	-	cd/m ²	Note 7

Test Conditions:

1. I_F= 20mA, and the ambient temperature is 25°C.
2. The test systems refer to Note 1 and Note 2.

Messrs.			
Product Specification	Model:	TAD84301HFR70N	Rev. NO.
			A
			Issued Date.
			APR.09,19

Note 1: Definition of optical measurement system.

The optical characteristics should be measured in dark room. After 5 Minutes operation, the optical properties are measured at the center point of the LCD screen. All input terminals LCD panel must be ground when measuring the center area of the panel.

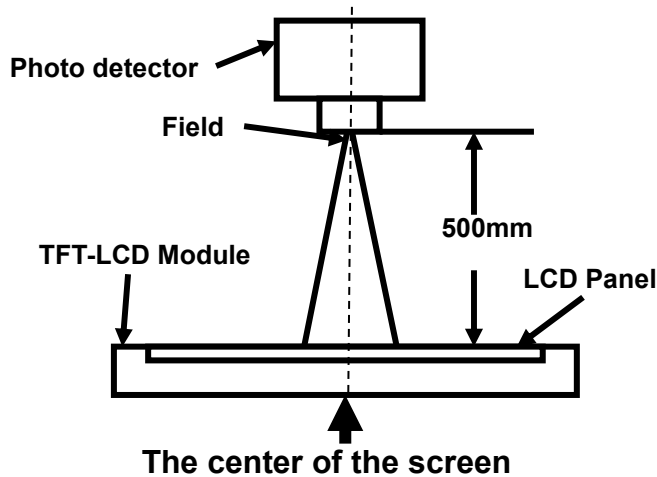

Note 2: Definition of viewing angle range and measurement system.

viewing angle is measured at the center point of the LCD.

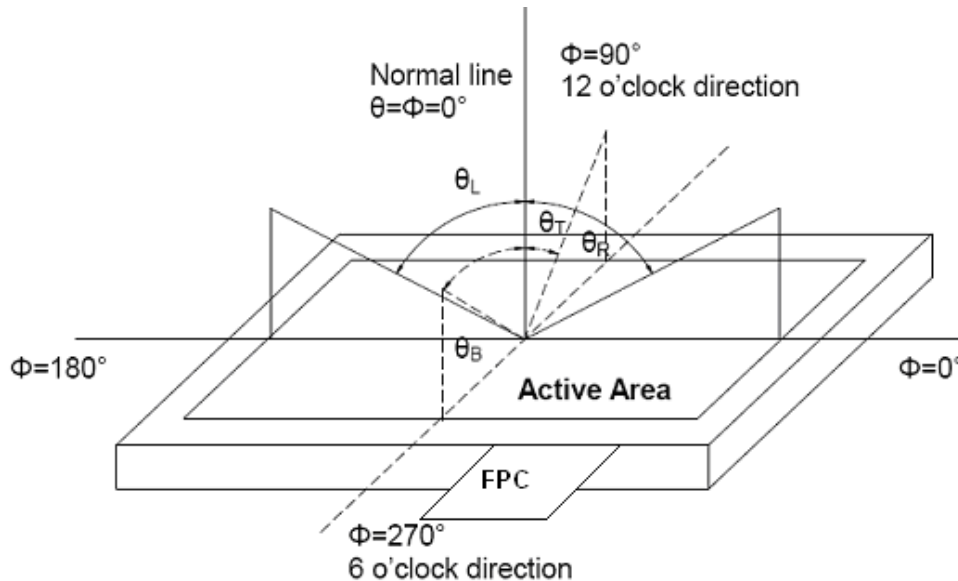

Note 3: Definition of contrast ratio

$$\text{Contrast ratio (CR)} = \frac{\text{Luminance measured when LCD is on the "White" state}}{\text{Luminance measured when LCD is on the "Black" state}}$$

“White state “: The state is that the LCD should drive by V_{white} .

“Black state”: The state is that the LCD should drive by V_{black} .

V_{white} : TBD V V_{black} : TBD V.

Note 4: Definition of Response time

Messrs.			
Product Specification	Model:	TAD84301HFR70N	Rev. NO.
			A
			Issued Date.
			APR.09,19

The response time is defined as the LCD optical switching time interval between “White” state and “Black” state. Rise time (T_{ON}) is the time between photo detector output intensity changed from 90% to 10%. And fall time (T_{OFF}) is the time between photo detector output intensity changed from 10% to 90%.

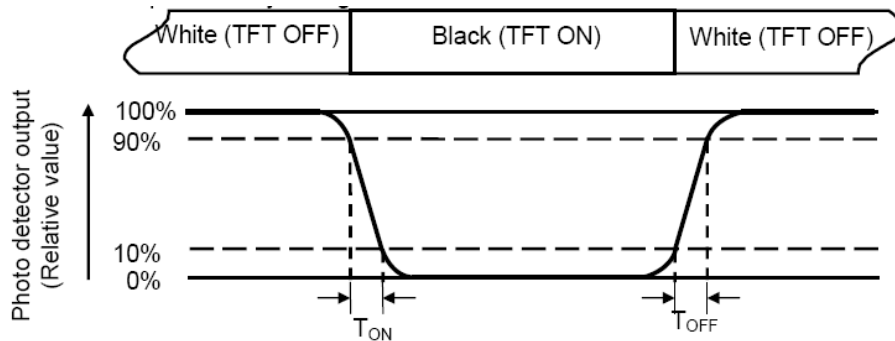

Note 5: Definition of color chromaticity (CIE1931)

Color coordinates measured at center point of LCD.

Note 6: Definition of Luminance Uniformity

Active area is divided into 9 measuring areas (Refer Fig. 2). Every measuring point is placed at the center of each measuring area.

$$\text{Luminance Uniformity (U)} = L_{\min} / L_{\max}$$

L-----Active area length W----- Active area width

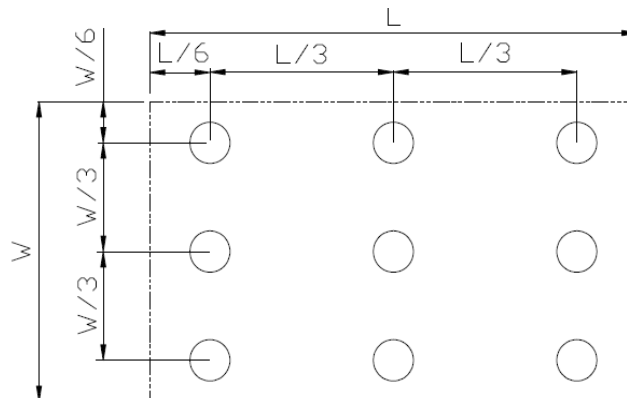

Fig. 2

L_{\max} : The measured Maximum luminance of all measurement position.

L_{\min} : The measured Minimum luminance of all measurement position.

Note 7: Definition of Luminance:

Measure the luminance of white state at center point.

Messrs.			
Product Specification	Model:	TAD84301HFR70N	Rev. NO.
			A
			Issued Date.
			APR.09,19

7 Environmental / Reliability Tests

No	Test Item	Condition	Remarks
1	High Temperature Operation	Ts=+70°C, 240hrs	Note1 IEC60068-2-1,GB2423.2
2	Low Temperature Operation	Ta=-20°C, 240hrs	IEC60068-2-1 GB2423.1
3	High Temperature Storage	Ta=+80°C, 240hrs	IEC60068-2-1 GB2423.2
4	Low Temperature Storage	Ta=-30°C, 240hrs	IEC60068-2-1 GB2423.1
5	High Temperature & High Humidity Storage	Ta=+60°C, 90% RH 240 hours	Note2 IEC60068-2-78 GB/T2423.3
6	Thermal Shock (Non-operation)	-30°C 30 min~+80°C 30 min, Change time:5min, 50 Cycles	Start with cold temperature, End with high temperature, IEC60068-2-14,GB2423.22
7	Electro Static Discharge (Operation)	C=150pF, R=330Ω · 5points/panel Air:±8KV, 5times; Contact:±4KV, 5 times; (Environment: 15°C ~ 35°C, 30% ~ 60%, 86Kpa ~ 106Kpa)	IEC61000-4-2 GB/T17626.2
8	Package Drop Test	Height:80 cm, 1 corner, 3 edges, 6 surfaces	IEC60068-2-32 GB/T2423.8

Note1: Ts is the temperature of panel's surface.

Note2: Ta is the ambient temperature of sample.

Note3: Before cosmetic and function test, the product must have enough recovery time, at least 2 hours at room temperature.

Note 4: In the standard condition, there shall be no practical problem that may affect the display function. After the reliability test, the product only guarantees operation, but don't guarantee all of the cosmetic specification.

Messrs.

Product Specification

Model:

TAD84301HFR70N

Rev. NO.

Issued Date.

A

APR.09,19

8 Mechanical Drawing

1	2	3	4	5	6	7	8	9																																																																																																																											
PART NUMBER		DESCRIPTION																																																																																																																																	
		<div style="display: flex; justify-content: space-between;"> <div style="width: 45%;"> <p>Notes:</p> <ol style="list-style-type: none"> Display : 4.3", TFT Resolution: 480xRGBx272 Viewing Direction: ALL Polarizer Mode: IPS (上光下移): Display Mode: Transmissive/normal Black LCD Driver IC: SC7283 Power Supply Voltage: 3.3V; Backlight: 10 Chip-white LED; Brightness: 40mk/700cd/m²(MIN), 900cd/m²(TYP); customer use □: Critical dimension: () Reference dimension; OPERATING TEMP: -20° C ~ +70° C STORAGE TEMP: -30° C ~ +80° C GENERAL TOLERANCE: ±0.2 Requirements on Environmental Protection:Rolls </div> <div style="width: 50%;"> <p>Dimensions: 83.00±0.5, 56.70±0.2, 2.80±0.1, 99.80±0.1, 52.75, 48.30, 59.40, 20.50±0.07, 18.30±0.3, 4.45±0.3, 67.20±0.2, 53.86 (A.A), 31.15, 95.04 (A.A), 105.50±0.2, 4.22, 4.3, 480*(RGB)272, 2.80±0.2, 0.13±0.05, MAX. 1.20, 0.30±0.05, 0.20±0.03, 0.30±0.03, 19.50, 0.50±0.07, 3.50±0.30, 0.70, 0.30, 0.26.</p> <p>Detail A Scale: 1</p> </div> </div>																																																																																																																																	
		<p>(CIRCUIT DIAGRAM)</p> <p>IF=40mA, VF=15.5V</p> <p>IF=35mA, VF=15.0V</p> <p>LED A(+)-> LED K(-)</p>																																																																																																																																	
		<table border="1" style="width:100%; border-collapse: collapse;"> <thead> <tr> <th>No.</th> <th>Part Name</th> <th>Quantity</th> </tr> </thead> <tbody> <tr><td>1</td><td>LED+</td><td></td></tr> <tr><td>2</td><td>LED-</td><td></td></tr> <tr><td>3</td><td>END</td><td></td></tr> <tr><td>4</td><td>VDD</td><td></td></tr> <tr><td>5</td><td>RO</td><td></td></tr> <tr><td>6</td><td>R1</td><td></td></tr> <tr><td>7</td><td>R2</td><td></td></tr> <tr><td>8</td><td>R3</td><td></td></tr> <tr><td>9</td><td>R4</td><td></td></tr> <tr><td>10</td><td>R5</td><td></td></tr> <tr><td>11</td><td>R6</td><td></td></tr> <tr><td>12</td><td>R7</td><td></td></tr> <tr><td>13</td><td>G0</td><td></td></tr> <tr><td>14</td><td>G1</td><td></td></tr> <tr><td>15</td><td>G2</td><td></td></tr> <tr><td>16</td><td>G3</td><td></td></tr> <tr><td>17</td><td>G4</td><td></td></tr> <tr><td>18</td><td>G5</td><td></td></tr> <tr><td>19</td><td>G6</td><td></td></tr> <tr><td>20</td><td>G7</td><td></td></tr> <tr><td>21</td><td>B0</td><td></td></tr> <tr><td>22</td><td>B1</td><td></td></tr> <tr><td>23</td><td>B2</td><td></td></tr> <tr><td>24</td><td>B3</td><td></td></tr> <tr><td>25</td><td>B4</td><td></td></tr> <tr><td>26</td><td>B5</td><td></td></tr> <tr><td>27</td><td>B6</td><td></td></tr> <tr><td>28</td><td>B7</td><td></td></tr> <tr><td>29</td><td>END</td><td></td></tr> <tr><td>30</td><td>DLK</td><td></td></tr> <tr><td>31</td><td>DISP</td><td></td></tr> <tr><td>32</td><td>HSYNC</td><td></td></tr> <tr><td>33</td><td>VSYNC</td><td></td></tr> <tr><td>34</td><td>DE</td><td></td></tr> <tr><td>35</td><td>NC</td><td></td></tr> <tr><td>36</td><td>END</td><td></td></tr> <tr><td>37</td><td>NC (R)</td><td></td></tr> <tr><td>38</td><td>NC (V)</td><td></td></tr> <tr><td>39</td><td>NC (A)</td><td></td></tr> <tr><td>40</td><td>NC (U)</td><td></td></tr> </tbody> </table>							No.	Part Name	Quantity	1	LED+		2	LED-		3	END		4	VDD		5	RO		6	R1		7	R2		8	R3		9	R4		10	R5		11	R6		12	R7		13	G0		14	G1		15	G2		16	G3		17	G4		18	G5		19	G6		20	G7		21	B0		22	B1		23	B2		24	B3		25	B4		26	B5		27	B6		28	B7		29	END		30	DLK		31	DISP		32	HSYNC		33	VSYNC		34	DE		35	NC		36	END		37	NC (R)		38	NC (V)		39	NC (A)		40	NC (U)	
No.	Part Name	Quantity																																																																																																																																	
1	LED+																																																																																																																																		
2	LED-																																																																																																																																		
3	END																																																																																																																																		
4	VDD																																																																																																																																		
5	RO																																																																																																																																		
6	R1																																																																																																																																		
7	R2																																																																																																																																		
8	R3																																																																																																																																		
9	R4																																																																																																																																		
10	R5																																																																																																																																		
11	R6																																																																																																																																		
12	R7																																																																																																																																		
13	G0																																																																																																																																		
14	G1																																																																																																																																		
15	G2																																																																																																																																		
16	G3																																																																																																																																		
17	G4																																																																																																																																		
18	G5																																																																																																																																		
19	G6																																																																																																																																		
20	G7																																																																																																																																		
21	B0																																																																																																																																		
22	B1																																																																																																																																		
23	B2																																																																																																																																		
24	B3																																																																																																																																		
25	B4																																																																																																																																		
26	B5																																																																																																																																		
27	B6																																																																																																																																		
28	B7																																																																																																																																		
29	END																																																																																																																																		
30	DLK																																																																																																																																		
31	DISP																																																																																																																																		
32	HSYNC																																																																																																																																		
33	VSYNC																																																																																																																																		
34	DE																																																																																																																																		
35	NC																																																																																																																																		
36	END																																																																																																																																		
37	NC (R)																																																																																																																																		
38	NC (V)																																																																																																																																		
39	NC (A)																																																																																																																																		
40	NC (U)																																																																																																																																		
		<table border="1" style="width:100%; border-collapse: collapse;"> <thead> <tr> <th>REVISION</th> <th>RECORD</th> <th>NAME</th> <th>DATE</th> <th>APPD.</th> </tr> </thead> <tbody> <tr> <td> </td> <td> </td> <td> </td> <td> </td> <td> </td> </tr> <tr> <td> </td> <td> </td> <td> </td> <td> </td> <td> </td> </tr> <tr> <td> </td> <td> </td> <td> </td> <td> </td> <td> </td> </tr> <tr> <td> </td> <td> </td> <td> </td> <td> </td> <td> </td> </tr> <tr> <td> </td> <td> </td> <td> </td> <td> </td> <td> </td> </tr> <tr> <td> </td> <td> </td> <td> </td> <td> </td> <td> </td> </tr> </tbody> </table>							REVISION	RECORD	NAME	DATE	APPD.																																																																																																																						
REVISION	RECORD	NAME	DATE	APPD.																																																																																																																															
		<table border="1" style="width:100%; border-collapse: collapse;"> <thead> <tr> <th>DWN.</th> <th>CHK.</th> <th>DATE:</th> <th>SCALE:</th> <th>TITLE</th> <th>UNITS:</th> <th>DWG. NO.:</th> <th>VER.:</th> </tr> </thead> <tbody> <tr> <td>Tony</td> <td>Kevin</td> <td>04/09/2019</td> <td>1:1</td> <td>TAD84301HFR70N</td> <td>mm</td> <td></td> <td>1.0</td> </tr> <tr> <td></td> <td>Donlin</td> <td></td> <td>1/1</td> <td></td> <td></td> <td></td> <td></td> </tr> </tbody> </table>							DWN.	CHK.	DATE:	SCALE:	TITLE	UNITS:	DWG. NO.:	VER.:	Tony	Kevin	04/09/2019	1:1	TAD84301HFR70N	mm		1.0		Donlin		1/1																																																																																																							
DWN.	CHK.	DATE:	SCALE:	TITLE	UNITS:	DWG. NO.:	VER.:																																																																																																																												
Tony	Kevin	04/09/2019	1:1	TAD84301HFR70N	mm		1.0																																																																																																																												
	Donlin		1/1																																																																																																																																
		<p style="text-align: center;">APEX SCIENCE & ENGINEERING CORP.</p>																																																																																																																																	



Messrs.			
Product Specification	Model:	TAD84301HFR70N	Rev. NO.
			A
			Issued Date.
			APR.09,19

9 Packing Drawing

9.1 Packing

No	Item	Model (Material)	Dimensions(mm)	Quantity	Remark
1	LCM module	TAD84301HFR70N	105.5 *67.20*2.8	TBD	
2	Tray	PET (Transmit)	485*330	TBD	Anti-static
3	Vacuum bag	Vacuum bag	600*500*0.05	3	
4	BOX	CORRUGATED PAPER	520*345*74	3	
5	Carton	CORRUGATED PAPER	544*365*250	1	
6	Desiccant	Desiccant	45*35	6	
7	Label	Label	100*100	3	
8	Label	-	-	-	

10.2 Packaging Specification and Quantity

(1)LCM quantity per tray(每盘模组数量):8pcs
(2)Total LCM quantity per group(每组模组总数量):48PCS(6 Tray 盘+1Empty tray 空盘)
(3)Total LCM quantity per carton(每组模组总数量):quantity per group(每组模组总数量)48pcs × group quantity per carton(每箱组数量)3=144pcs

Messrs.		Model: TAD84301HFR70N	Rev. NO.	Issued Date.
Product Specification			A	APR.09,19

Desiccant \times ⑥ 

Use empty tray ② 

Lcm ① 

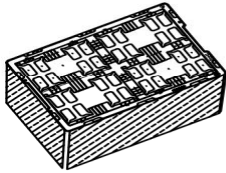
⑧ 

将LCM产品放入6个吸塑盘中，
每盘模组数量为：8PCS

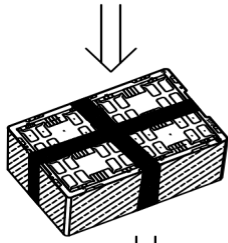

将用防尘袋包装好的内盒放入外形中，
每箱模组数量为：6*8*3=144 (pcs)

真空袋打包

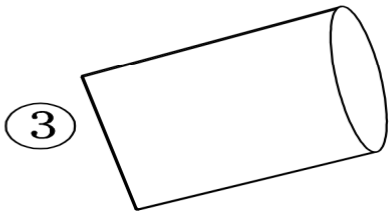

48 LCMs per Box

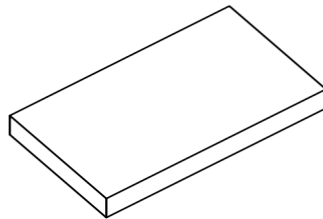
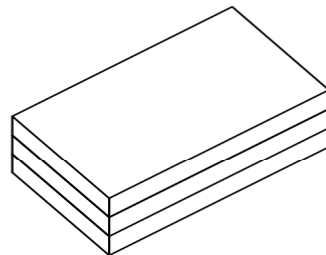
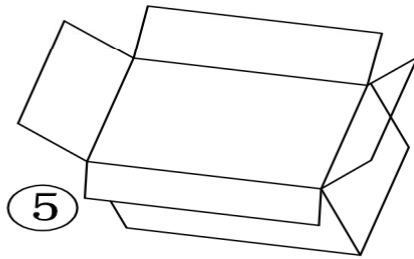
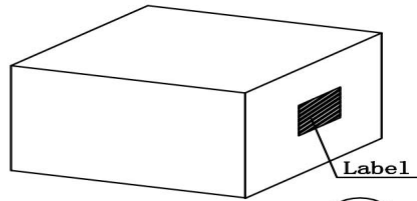
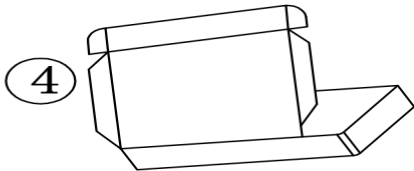

Messrs.			
Product Specification	Model:	TAD84301HFR70N	Rev. NO.
			A
			Issued Date.
			APR.09,19

10 Inspection Criteria

10.1 Inspection conditions

- Inspection direction should be perpendicular to display surface within the viewing angle as per signed specification.
- In case there is a specific need to perform an Incoming Quality inspection Customer will follow rules herein after.
Sampling Plan & Sampling Method According to ISO2859-1(Equivalent to MIL-STD-105/E) General inspection level II, will be used for IQC and gives criteria for batch acceptance or rejection.
AQL Definition, AQL=0.25
- Inspection shall be performed under the conditions from 20W to 80W (from 300 to 700 Lux): fluorescent lamp; parts will be held such that the light is not reflecting directly to the viewer.
- Ambient Temperature: $25 \pm 5^{\circ}\text{C}$
- The distance between inspector's eyes & product surface should be from 30cm to 50cm maximum in all directions.
- Time for cosmetic inspection is limited to 10 seconds for the screen and 10 seconds for other area. This does not include functional check.
- Functional test must be made by using a specific jig provided by supplier

10.2 Definitions

Definition of areas

A is the Active Area of the display (dot area)

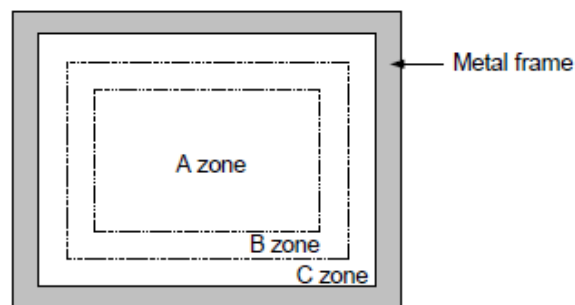

B is the Viewing Area

C is the Area between B zone and metal frame





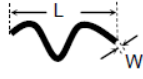

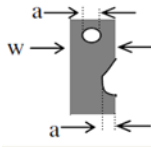
Messrs.			
Product Specification	Model:	TAD84301HFR70N	Rev. NO.
			A
			Issued Date.
			APR.09,19

10.3 Standard and rejection criteria's

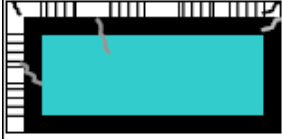
Defect	Criteria				
Circular	Size (mm)		Acceptable Qty		$\phi = (L+W)/2$, L: Length, W: Width 
			Zone		
			A	B & C	
	$\Phi \leq 0.1$		Ignore	Ignore	
	$0.10 < \Phi \leq 0.2$		2		
	$0.2 < \Phi < 0.25$		1		
$\Phi > 0.25$		None			
Total		2*			
* No include $\Phi \leq 0.10$					
Dirt spot(s), concavo-convex spot & stab spot and all Spot defects. * Distance between 2 defects should be more than 10 mm apart.					
Linear	Size (mm)		Acceptable Qty		L: Length, W: Width 
	L	W	Zone		
			A	B & C	
	Ignore	$W \leq 0.01$	Ignore	Ignore	
	$L \leq 3$	and $0.01 < W \leq 0.03$	2		
	$L \leq 3$	and $0.03 < W \leq 0.05$	1		
$L > 3$	or $0.05 < W$	None			
Total		3			
Linear scratch, linear foreign material (fiber ...), dirt line.					
Polarizer Bubble Bubbles caught under polarised film	Size (mm)		Acceptable Qty		$\phi = (L+W)/2$, L: Length, W: Width 
			Zone		
			A	B & C	
	$\Phi \leq 0.15$		Ignore	Ignore	
$0.15 < \Phi \leq 0.25$		2			
$\Phi > 0.25$		None			
Distance between 2 defects should be more than 20 mm apart.					
Polarizer Dent	Size (mm)		Acceptable Qty		$\phi = (L+W)/2$, L: Length, W: Width 
			Zone		
			A	B & C	
	$\Phi < 0.25$		Ignore	Ignore	
$0.25 \leq \Phi \leq 0.35$		3			
$\Phi > 0.35$		None			
FPC	default		Sanction		
	Open Circuit		Rejected		
	Dent Or Pinhole (W=circuitry width)	$a \leq W/3$	Rejected		
		$a > W/3$	Rejected		
	Oxidation, contamination and distortion		Rejected		
Copper peeling		Rejected			

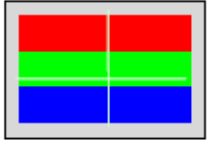
Messrs.			
Product Specification	Model:	TAD84301HFR70N	Rev. NO.
			A
			Issued Date. APR.09,19

Connection	<p><u>Number of connection/disconnection</u>: After 10 connection/disconnection, the FPC can be inserted a new time with full electrical connection and no visible damage else Rejected</p> <p><u>Traction on FPC</u>: Stick a 0,1kg weight on display, and then hold display by FPC during 10 minutes. display must stay fully functional with any visible damage marks else Rejected</p> <p><u>Bending of FPC</u>: display with its FPC is placed horizontally on a table. Fold the FPC from its middle (180° to 0°) then unfold it (180 to 0°). FPC is folded with a 0 mm radius. Perform this test 3 times. Display must be fully functional with no micro crack on tracks else Rejected</p>
Glass Cracks	 <p>no glass cracks, if this defect is present, the display is Rejected</p>
Bezel	No rust, no distortion and no visible fingerprints, stains or other contamination else Rejected
PCB	No distortion, no oxidation or no contamination on PCB else Rejected
Surface smudginess	No contamination on display like, fingerprints, water mark, or any residue which can not be removed on the surface of the display else Rejected
Polarise film Defect	Dust under polarised film Defective polarised film (glossy, dirty or clotted)
Newton Rings	No Newton Rings (visible with or without backlight) else Rejected
Air gap Arch	No Air gap (visible with or without backlight, concern display+touch panel) else Rejected
Mura irregular luminosity variation	Mura is a typical vision defect of display panel, appearing as local lightness variation with low contrast and blurry contour By 6% ND Filter
No function or No display	 <p>if this defect is present, the display is Rejected</p>
Missing vertical or horizontal Line / segment	 <p>if this defect is present, the display is Rejected</p>
Darker or lighter vertical / horizontal Line / segment	 <p>if this defect is present, the display is Rejected</p>
Abnormal display If visible Rejected	<p>Display defect, Irregular function of display (no light or with apparent waves, spots and other imperfections) Signal Error, Signal errors manifested through colour irregularities, interference, shadows, slow screen reaction and others</p> <p>H-Block Horizontal block permanently lighted or dark (incl. colours) H-Line Horizontal line permanently lighted or dark (incl. colours) V-Block Vertical block permanently lighted or dark (incl. colours) V-Line Vertical line permanently lighted or dark (incl. colours)Rejected</p> <p>Mura Black Large or small (1cm) black mura Manufacturing defects Cell defect Light halo around a defective pixel Light leakage Light leaking beyond the image format Mura Colour (yellow, strips, etc.). Irregular colour distribution. Mura White Large or small (1cm) white mura Rainbow effect. Bright or Dark Halo effect Dominance color effect</p>
Flicker	Flickering more than -26DB, screen image , if visible Rejected
Bright / Dark Point	See section 10.4 Rejected
Backlight	If there is no Backlight or Dark Backlight, the display is Rejected Backlight is not homogeneous Rejected

Messrs.			
Product Specification	Model:	TAD84301HFR70N	Rev. NO.
			A
			Issued Date.
			APR.09,19

Mechanical issue	If the display is Out of tolerance, the display is Rejected
Electrical characteristics	If electrical characteristics are out of tolerance, the display is Rejected
Optical characteristics	If optical characteristics are out of tolerance, the display is Rejected
Identification / marking	If there is Illegible / wrong / double or no marking / label, the display is Rejected
Cosmetic Defects unlisted	All other defect related with cosmetic (marking, painting...) Customer will follow drawing else Rejected

10.4 Pixel defect criteria

Pixel (or dot) definition

A picture element made up of three primary colour sub-pixels (red, green, and blue)

Sub-pixel definition

A single point of light representing a primary colour (red, green or blue), which combines with the other two primary colour sub-pixels to form a complete pixel. (Each Sub-pixel corresponds to a transistor).

Defect definition

Sub-pixel is counted as a defect when it is always light-on (constantly bright) or always light-off (constantly dark). Defective area must be $\geq 0,33$ sub-pixel ($1/3$).

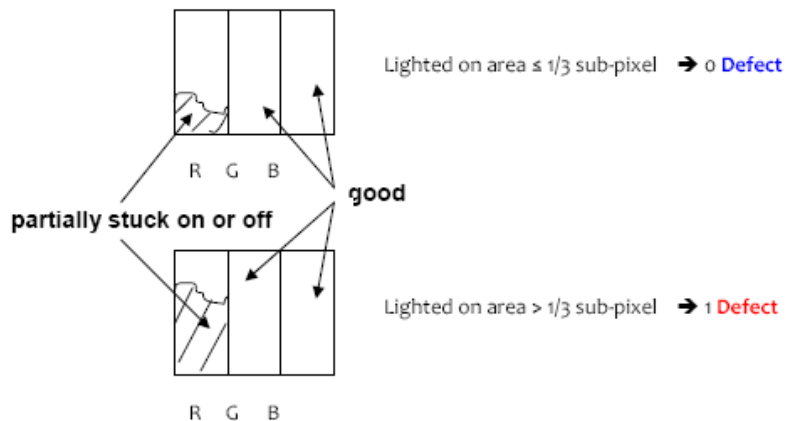

Pixel is counted as a defect when:

- 2 of its sub pixels are always light-on (constantly bright) or always light off (constantly dark).
- Pixel is always light on (constantly white) or light off (constantly black)

Area definition

Blue area = Active Area
 Dark blue area = I area
 Light blue area = J area
 Red area = non Active Area

Messrs.			
Product Specification	Model:	TAD84301HFR70N	Rev. NO.
			A
			Issued Date.
			APR.09,19

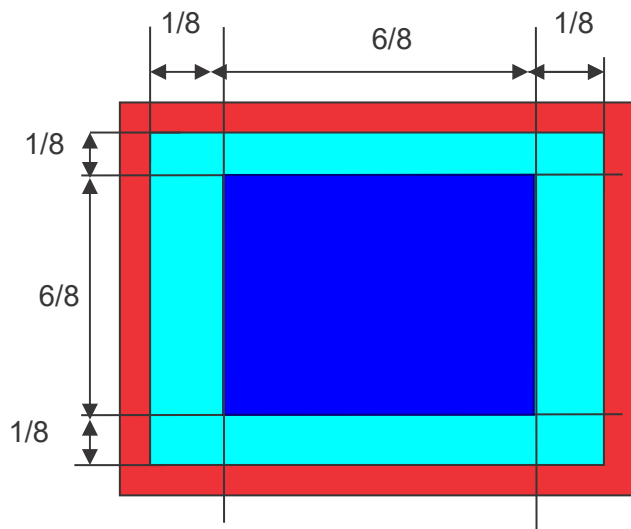

Criteria definition

Area	acceptable quantity		
	I	J	non active
Constantly bright Sub Pixel	1	1	ignore
Constantly bright Pixel	0	1	ignore
Constantly dark 1 Sub Pixel	0	1	ignore
Constantly dark Pixel	0	1	ignore

Maximum Number of defect on the same unit = 1 (I=0 and J=1 or I=1 and J=0)